

General Specifications

MODEL UT450 Digital Indicating Controller



GS 05D01C12-01E

■ General

Model UT450 Digital Indicating Controller is a simple, micro-processor based digital indicating controller with basic control capability and the user-friendly large numerical display. The UT450 features as standard many functions which are necessary for various control applications, and all of these functions such as control function, control computation function, signal computation function, etc. can be configured by using the keys on the front panel. The instrument has an Auto-tuning, an overshoot suppressing function "SUPER" and a hunting suppressing function "SUPER2" built in as standard. It is suitable for a diverse range of applications, with position-proportional control and heating/cooling control models also available.

■ Main Features

- Extra-large digital display allows the indicated values to be read even from a long distance. LEDs of 20 mm height are used for the process variable display. This is a 5-digit display for higher resolution.
- Enabling the operator to start control operation immediately after simply entering the settings.
- Parameters can be easily set using a personal computer. ("Parameter setting tool (model LL100)" sold separately is required.)
- Universal input and output enables users to set or change freely the type of measured inputs, measurement range, type of control output, etc. from the front panel.
- In addition to general purpose models (universal output), the position-proportional model (relay output) or the heating/cooling control model (universal output) can be specified.
- Contact inputs (up to 7 points) can be employed and functions assigned to each contact (The maximum number of points varies depending on the specification code.)
- Various communication function are provided. Communication is possible with personal computer, programable logic controller, and other controllers.

■ Functional Specifications

● Control Computation Functions

The following control computation functions can be selected:

Continuous PID control, Time-proportional PID control, Relay ON/OFF control, Position-proportional PID control (for UT450-1□) and Heating/Cooling control (for UT450-2□).

Target setpoint and PID parameter:

Maximum eight sets of target setpoint and PID parameter can be set.

Zone PID selection:

PID parameter set switching in up to 7 measured input zones.

Auto-tuning:

Available as standard.

"SUPER" function:

Overshoots generated by abrupt changes in the target setpoint or by disturbances can be suppressed.

UT450



UT450E

"E" indicates the model with expanded functions.



"SUPER2" function:

The function stabilizes the state of control that is unstable due to hunting, etc. without requiring any change in PID constants, when the load and/or gain varies greatly, or when there is a difference between the characteristics of temperature zones.

Preset output function:

When the instrument is in STOP mode, measured input is burnt-out, or an abnormality is found in an input circuit, a preset setpoint is output as a control output.

Control cycle time: 200 ms

Operation Mode Switching

(Note: Communication enables all the following mode switching to be executed.)

AUTO/MANUAL switching:

Bumpless switching between automatic operation mode and manual control mode is available by using the front key or contact input. The contact input has priority over front key input or switching by communication.

RUN/STOP switching:

Switching by contact input (bumpless for switching from STOP to RUN). The contact input has priority over switching by communication. In RUN mode, control computation is activated. In STOP mode, control computation ceases and a preset value is output as a control output while other functions operate normally.

REMOTE/LOCAL switching:

Switching between remote setpoint and local setpoint by instrument operation or contact input. The contact input has priority over instrument operation or switching by communication. For remote to local switching, either bumpless tracking (employing the remote setpoint on switching as the local setpoint) or without tracking (directly switching the local setpoint) can be specified.

Control Parameters Setting Range

- Proportional band: 0.1 to 999.9%
 0.0 to 999.9% (for heating/cooling PID control) 0.0% available for ON/OFF control
- Integral time: 1 to 6,000 s, or OFF (for Manual reset)
- Derivative time: 1 to 6,000 s, or OFF
- ON/OFF control hysteresis: 0.0 to 100.0% of measured input range width
- Preset output: -5.0 to 105.0% (0 mA or less cannot be output)
- Output limiter:
 Setting range: -5.0 to 105.0% for both high and low limits
 However, "low limit setpoint < high limit setpoint" must be satisfied.
 In case of heating/cooling PID control, upper limiter for heating and upper limiter for cooling.
- Shutdown function:
 When manual control is carried out with 4 to 20 mA output, control output can be output down to about 0 mA (shutdown is specified for -5.0% or less).
- Rate-of-change limiter for output:
 OFF or 0.1 to 100.0%/s
- Deadband for heating/cooling control:
 -100.0 to 50.0% for output range
- Deadband for position-proportional control:
 1.0 to 10.0% for output

● Configuration of Input/Output Signal

Measured Input Computations

Input processing, Bias addition (-100.0 to 100.0%), and First order lag filter (OFF, time constant 1 to 120 s)

Remote Input Computations

(Applied to remote input only)

Input processing, Bias addition (-100.0 to 100.0%), Ratio multiplication (0.001 to 9.999), First order lag filter (OFF, time constant 1 to 120 s)

● Alarm Functions

Alarm types:

PV high limit, PV low limit, Deviation high limit, Deviation low limit, Deenergized on deviation high limit, Deenergized on deviation low limit, Deviation high and low limits, High and low limits within deviation, Deenergized on PV high limit, Deenergized on PV low limit, SP high limit, SP low limit, Output high limit, Output low limit.

Alarm setting range:

PV/SP alarm: -100 to 100% of measured input range
 Deviation alarm: -100 to 100% of measured input range width
 Output alarm: -5.0 to 105.0% of output range
 Alarm hysteresis: 0.0 to 100.0% of measured input range width

Stand-by action:

Stand-by action can be set to make PV/deviation alarm OFF during start-up or after SP change until SP reaches the normal region.

Delay timer:

0.00 to 99.59 (minute, second)
 An alarm is output when the delay timer expires after the alarm setpoint is reached. Setting for each alarm is possible.

Timer function (stabilization of control status notification event) (Alarm1 only)

This function sets the alarm 1 output to ON when a preset time (timer setting) elapses after a PV has reached the control target setpoint hysteresis band to notify that control processing has reached its stabilized status. Restarted in RUN/STOP or target value switching.

Other alarm actions

Sensor grounding alarm: Detects sensor deterioration and outputs an alarm.
 Fault-diagnosis alarm: For input burn-out, A/D conversion error, or thermocouple reference junction compensation error.
 FAIL output: Abnormality in software or hardware.

Number of alarm settings: 4 (maximum)

The alarm status can be read via communication in addition to output as the above alarm output.

Alarm output points (see also the item "Contact output")

- Number of contact (relay) outputs:
3 (standard)
- Number of contact (transistor open collector) outputs:
1 (when optional specification code is specified as 1 or 3)

Any of PV alarm, deviation alarm, SP alarm, output alarm, Fault-diagnosis alarm, sensor grounding alarm and FAIL output can be assigned to contacts for the above number of outputs. However, the timer delay alarm can be assigned to the alarm 1 output only.

● Display and Operation Functions

PV Display

PV1 is displayed on the 5-digit display. The number of display digits is 4 or 5. For thermocouple or RTD, data below the decimal point can be set not to display. The display range is -19999 to 30000 and the display span is 30000 or less. [450.00 appearing in the product photograph on page 1 cannot actually be displayed.]

Setpoint Display

A parameter name is displayed in the 3-digit display and data in the 5-digit display. There are four kind of displays of operation, operating parameter setting, setup parameter setting and SELECT display.

Operating display:

Setpoint, control output, etc. are displayed.

Operating parameters setting display:

The Operating parameters, which are mainly changed during operating, such as PID constant, are displayed.

Setup parameters setting display:

The Setup parameters to configure the functions of the instrument before starting operation are displayed.

SELECT display:

Up to five displays which are frequently accessed can be selected from the Operating parameters setting display and Setup parameters setting display to be displayed in the SELECT display.

Status Lamps

Alarm indicating lamp:

Four lamps, AL1, AL2, AL3, and AL4

Operation mode indicating lamp:

REM (remote operation), MAN (manual mode operation)

Deviation indicating lamp:

▲Plus deviation, ▼Minus deviation, and ■ deviation in normal range

Operation Keys

△, ▽ keys: Increase or decrease setpoints and other parameters displayed in the setpoint display.

SET/ENT key: Used for setting or changing set data, switching the displayed contents, and switching operation modes except for A/M.

A/M key: Operation mode switching (Auto/Man)

Security Function

Key-lock from parameters setting and operation can be inhibited by a password.

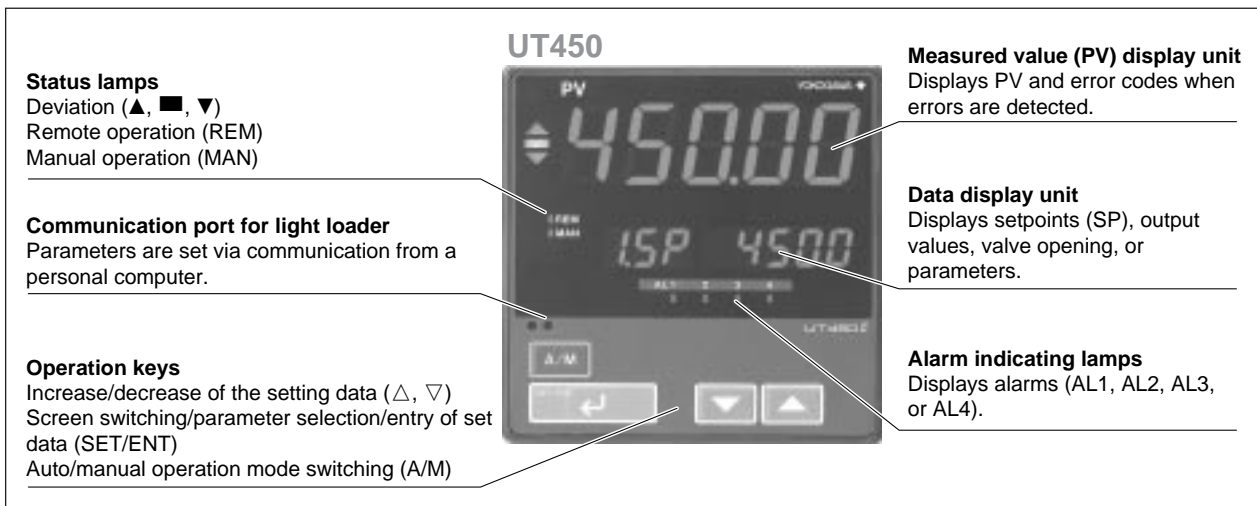

● Communication Functions

(For optional specification code □1 or □2 only)

This controller has 4 types of communication protocol with one communication interface. Communication is possible with personal computer, programmable logic controller, and other controllers.

Communication Protocol

Computer link communication:

Communication protocol with a personal computer

Ladder communication:

Communication protocol with programmable logic controllers.

MODBUS communication:

Communication protocol with a personal computer or PLC.

Coordinated operation:

Protocol for coordinated operation with more than one GREEN SERIES controller. The UT450 controller can be connected as a master or slave station.

RS-485 Communication Interface

The RS-485 communication interface (conforms to EIA RS485) can be used for personal computer link, ladder communication, MODBUS communication, or for coordinated operation.

Maximum number of connectable controllers:

GREEN SERIES controller 31

Maximum communication distance: 1200 m

Communication method:

Two-wire half-duplex or four-wire half-duplex, start-stop synchronization, and non-procedural

Communication rate:

600, 1200, 2400, 4800, or 9600 bps

Examples of Communication System Configuration Diagram

(1) Personal computer link communication/MODBUS communication

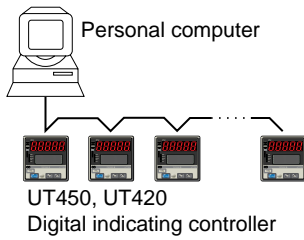

(2) Ladder communication

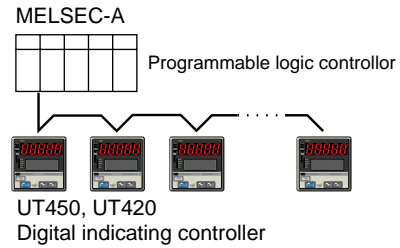

(3) Coordinated operation

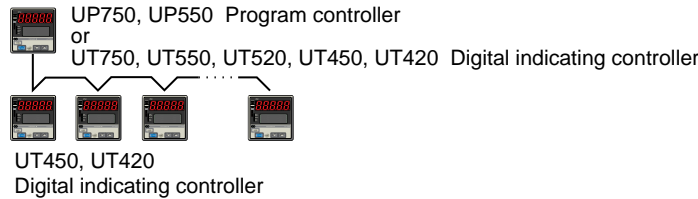

■ Hardware Specifications

● Input/Output Signal Specifications

Measured Input Signal

Number of input points: 1
 Input type, measurement range, and measurement accuracy:
 The type of input and measurement range can be specified using the input range code shown in the table below.

Sampling period: 200 ms

Burnout detection:

Activated for thermocouple (TC) input, RTD input, or standard signal of 0.4 to 2 V or 1 to 5 V.
 Possible to specify a travel of upscale, downscale, or off.
 For standard signal input, set to burn out at 0.1 V or less.

Input bias current: 0.05 μA (for TC or RTD b-terminal)

Specified current(RTD): about 0.13 mA

Input resistance: 1 MΩ or more for TC or mV input

Approx 1 MΩ for DC voltage input

Allowable signal source resistance:

250 Ω or less for TC or mV input
 Signal source resistance effect 0.1 μV/Ω or less

2 kΩ or less for DC voltage input

Signal source resistance effect

Approx. 0.01%/100 Ω

Allowable leadwire resistance (for RTD input):

Maximum 150 Ω/one wire (Lead resistances of three wires must be equal.)

However, it must be 10 Ω/one wire for the range of -150.0 to 150.0°C.

Effect of wiring resistance: ±0.1°C/10Ω

Allowable input voltage:

±10 V DC for TC/mV/RTD input

±20 V DC for DC voltage input

Noise rejection ratio:

Normal mode 40 dB (50/60 Hz) or more

Common mode 120 dB (50/60 Hz) or more

Reference junction compensation error:

±1.0°C (15 to 35°C), ±1.5°C (0 to 15°C and 35 to 50°C)

Applicable standards:

JIS, IEC, and DIN (ITS-90) for TC and RTD

Input type		Input range code	Instrument range (°C)	Instrument range (°F)	Instrument accuracy*1	
Unspecified(when shipped from the factory)		OFF	Set the data item PV input type "IN" to the OFF option to leave the PV input type undefined.			
Thermocouple	K	1	-270.0 to 1370.0°C	-450.0 to 2500.0°F	±0.1% ±1 digit of instrument range at 0°C or more ±0.2% ±1 digit of instrument range at less than 0°C • However, ±2% ±1 digit of instrument range for type K at temperatures less than -200°C. • However, ±1% ±1 digit of instrument range for type T at temperatures less than -200°C.	
		2	-270.0 to 1000.0°C	-450.0 to 2300.0°F		
		3	-200.0 to 500.0°C	-200.0 to 1000.0°F		
	J	4	-200.0 to 1200.0°C	-300.0 to 2300.0°F		
	T	5	-270.0 to 400.0°C	-450.0 to 750.0°F		
		6	0.0 to 400.0°C	-200.0 to 750.0°F		
	B	7	0.0 to 1800.0°C	32 to 3300°F		±0.15% ±1 digit of instrument range at 400°C or more ±5% ±1 digit of instrument range at less than 400°C
	S	8	0.0 to 1700.0°C	32 to 3100°F		±0.15% ±1 digit of instrument range
	R	9	0.0 to 1700.0°C	32 to 3100°F		
	N	10	-200.0 to 1300.0°C	-300.0 to 2400.0°F		±0.1% ±1 digit of instrument range ±0.25% ±1 digit of instrument range for temperature at less than 0°C
	E	11	-270.0 to 1000.0°C	-450.0 to 1800.0°F		±0.1% ±1 digit of instrument range at 0°C or more ±0.2% ±1 digit of instrument range at less than 0°C • However, ±1.5% ±1 digit of instrument range for type E at temperature less than -200°C.
	L (DIN)	12	-200.0 to 900.0°C	-300.0 to 1600.0°F		
	U (DIN)	13	-200.0 to 400.0°C	-300.0 to 750.0°F		
			0.0 to 400.0°C	-200.0 to 1000.0°F		
	W (DIN)	15	0.0 to 2300.0°C	32 to 4200°F		±0.2% ±1 digit of instrument range
	Platinel 2	16	0.0 to 1390.0°C	32.0 to 2500.0°F		±0.1% ±1 digit of instrument range
	PR20-40	17	0.0 to 1900.0°C	32 to 3400°F		±0.5% ±1 digit of instrument range at 800°C or more Accuracy not guaranteed for temperature less than 800°C
	W97Re3-W75Re25		0.0 to 2000.0°C	32 to 3600°F		
RTD	JPt100	30	-200.0 to 500.0°C	-300.0 to 1000.0°F	±0.1% ±1 digit of instrument range (Note1) (Note2)	
		31	-150.00 to 150.00°C	-200.0 to 300.0°F	±0.2% ±1 digit of instrument range (Note1)	
	Pt100	35	-200.0 to 850.0°C	-300.0 to 1560.0°F	±0.1% ±1 digit of instrument range (Note1) (Note2)	
		36	-200.0 to 500.0°C	-300.0 to 1000.0°F		
		37	-150.00 to 150.00°C	-200.0 to 300.0°F	±0.2% ±1 digit of instrument range (Note1)	
Standard signal	0.4 to 2V	40	0.400 to 2.000 V	Display range -19999 to 30000 Display span 30000 or less (Decimal point position changeable)	±0.1% ±1 digit of instrument range	
	1 to 5V	41	1.000 to 5.000 V			
DC voltage	0 to 2V	50	0.000 to 2.000 V			
	0 to 10V	51	0.00 to 10.00 V			
	-10 to 20mV	55	-10.00 to 20.00 mV			
	0 to 100mV	56	0.0 to 100.0 mV			

Note1: The accuracy is ±0.3°C of instrument range ±1 digit for a temperature range from 0 to 100°C.

Note2: The accuracy is ±0.5°C of instrument range ±1 digit for a temperature range from -100 to 200°C.

*1: Performance in the standard operating conditions (at 23±2°C, 55±10% RH, and 50/60Hz power frequency)

Remote Input Signal

(UT450-□1, -□2, or -□4 only)

Functions: Remote input (analog input) for setting SP

Input type: Settable within the range of voltage input
 1 to 5 V DC, 0 to 2 V DC, 0 to 10 V DC or 0.4 to 2.0 V DC.

Number of inputs: 1 point

Sampling period: 200 ms

Input resistance: Approx. 1 MΩ

Input accuracy: ±0.3% ±1 digit of F.S. for 0 to 2 V DC input

±0.2% ±1 digit of F.S. for 0 to 10 V DC input

±0.375% ±1 digit of F.S. for 0.4 to 2.0 V DC range

±0.3% ±1 digit of F.S. for 1 to 5 V DC range

Performance in the standard operating conditions (at 23±2°C, 55±10% RH, and 50/60Hz power frequency)

Feedback Resistance Input Signal

Provided for UT450-1□ only. Valid for position proportional PID control.

Slidewire resistance:

Total resistance 100 Ω to 2.5 kΩ (with detection of slidewire breakage)

Measuring resolution ±0.1% of total resistance

24V DC Loop Power Supply for Sensor

Supplies power to the 2-wire transmitter. The current signal is converted to a voltage signal by placing a resistor (arbitrary from 10 to 250 Ω) and is read by the measured input block.

Supply voltage 21.6 to 28.0 V DC, maximum supply current about 30 mA (only for models with 24 V DC loop power supply)

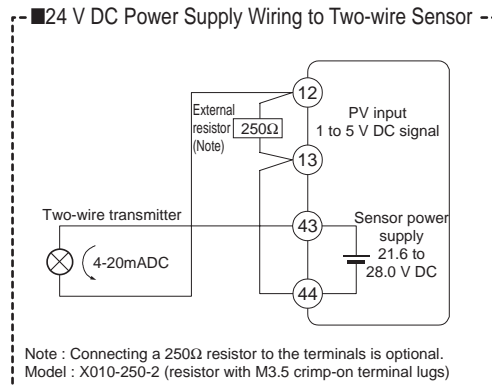

Retransmission Output

Any of the PV, target setpoint or control output is output. Or this can be used for 15 V DC sensor power supply.

- Number of output points: 1
- Output signal: 4 to 20 mA DC
- Load resistance: 600 Ω or less
- Output accuracy: ±0.1% of span
- Performance in the standard operating conditions (at 23±2°C, 55±10% RH, and 50/60Hz power frequency)

When using for 15 V DC sensor power supply:

- Supply voltage 14.5 to 18.0 V DC, maximum supply current about 21 mA (with the protection circuit at field shortcircuit)

Control Outputs

Select 1 or 2 points (UT450-2□) from the following output types depending on the product model. Relay contact output for position proportional PID control (UT450-1□).

- Current output**
 - Number of output points: 1 or 2 (for heating/cooling type) (switchable to voltage pulse output)
 - Output signal: 4 to 20 mA DC
 - Load resistance: 600 Ω or less
 - Output accuracy:
 - ±0.1% of span
 - Performance in the standard operating conditions (at 23±2°C, 55±10% RH, and 50/60Hz power frequency)

Voltage pulse output

- Number of output points: 1 or 2 (for heating/cooling model) (switchable to current output)
- Output signal:
 - ON voltage 12 V DC or more (load resistance 600 Ω or more; current on short-circuiting about 30 mA)
 - OFF voltage 0.1 V DC or less
- Resolution: 10 ms or 0.1% of output value, whichever is greater.

Relay contact output

- Number of output points: 1 or 2 (for heating/cooling model)
- Output signal: At three terminals of NC, NO, and Common
- Contact rating: 250 V AC, 3 A or 30 V DC, 3 A (resistive load)
- Resolution: 10 ms or 0.1% of output value, whichever is greater.

Contact Inputs

- Usage: Target setpoint switching, REMOTE/LOCAL switching, or RUN/STOP switching
- Number of input points:
 - Varies with optional codes (as shown below):

Model and Suffix Code	Number of Input Points
UT450- □ 0	2
UT450- □ 1	7
UT450- □ 2	3
UT450- □ 3	6
UT450- □ 4	3

- Input type: Non-voltage contact input or transistor open collector input
- Input contact rating: 12 V DC, 10 mA or more (for non-voltage contact input)

On/off detection:

- For non-voltage contact input,
 - On contact resistance 1 k Ω or less;
 - Off contact resistance 20 k Ω or more
- For transistor contact input,
 - On 2 V or less;
 - Off leak current 100 μA or less

Minimum retention time for status detection: 0.6 s

Contact Outputs

- Usage: Alarm output, FAIL output
- Number of output points:
 - Varies with optional codes (as shown below):

Model and Suffix Code	Number of Output Points
UT450- □ 0	3
UT450- □ 1	4
UT450- □ 2	3
UT450- □ 3	4
UT450- □ 4	3

- Relay contact rating: 240 V AC, 1 A or 30 V DC, 1 A
- Transistor contact rating: 24 V DC, 50 mA

● **Display Specifications**

- Measured value (PV) display:
 - 5-digit seven-segment red color LED display;
 - height of letters 20 mm
- Data display: 3 digits + 5 digits, seven-segment red color LED display; height of letters 9.3 mm
- Status indicating lamps: LEDs

● **Conformance to Safety and EMC Standards**

- Safety standard:
 - Conforms to IEC1010-1: 1990 and EN61010-1: 1992
 - Certified for CSA1010
 - The overvoltage category of each input is CAT II (IEC1010-1)
 - Certified for UL508 application
- EMC standard:
 - To the following EMC standards. During test, the controller continues to operate with the measurement accuracy within ±20% of the range:
 - For EMI (emission), EN55011, Class A Group 1
 - For EMS (immunity), EN50082-2: 1995

● **Construction, Installation, and Wiring**

- Construction: Dust-proof and Drip-proof front panel conforming to IP55.
 - For side-by-side close installation, controller loses its dust-proof and drip-proof protections.
- Material of the body: ABS resin and polycarbonate
- Case color: Black
- Weight: Approx. 1 kg or less
- External dimensions: 96W × 96H × 100D (from the panel face) (mm)
- Mounting: Direct panel mounting; mounting bracket, one each for upper and lower mounting
- Panel cutout dimensions: 92^{+0.8}₀W × 92^{+0.8}₀H (mm)
- Mounting attitude:
 - Up to 30 degrees from horizontal; Must not face downward.

Wiring connection:

With M3.5 screw terminals (for signal, power and grounding wiring)

● Power Supply and Isolation

Power supply: Rated voltage 100 to 240 V AC ($\pm 10\%$), 50/60 Hz

Power consumption: MAX. 20 VA (MAX. 8.0 W)

Memory backup: EEPROM. Service life approx. 100000 times of writings

Withstanding voltage:

1500 V AC for 1 min.

between primary terminals and secondary terminals (Note)

1500 V AC for 1 min.

between primary terminals and ground terminal (Note)

1500 V AC for 1 min.

between ground terminal and secondary terminals

500 V AC for 1 min.

between secondary terminals

(where primary terminals stand for power and relay output terminals and secondary terminals, analog input and output signal terminals, voltage pulse output terminals, and contact input terminals.)

Note. The withstanding voltage is specified as 2300 V AC per minute to provide a margin of safety.

Isolation resistance:

20 M Ω or more for 500 V DC applied

between power terminals and ground terminal

Grounding: Class 3 grounding (grounding resistance of 100 Ω or less)

Isolation Specifications**Measured input terminal :**

Isolated from other input/output terminals, but not isolated from internal circuits.

Remote input terminal:

Isolated from other input/output terminals and internal circuits.

24 V DC loop power supply terminal:

Isolated from other input/output terminals and internal circuits.

Terminals for control output (current or voltage pulse) and retransmission output:

Not isolated between control output and retransmission output terminal, but isolated from other input/output terminals and internal circuits.

Relay contact control output terminals:

Isolated from other contact output terminals, other input/output terminals and internal circuits.

Contact input terminals:

Not isolated from other contact input terminals mutually and communication terminals, but isolated from other input/output terminals and internal circuits.

Relay contact alarm output terminals:

Isolated from other input/output terminals and internal circuits.

Transistor contact alarm output terminals:

Not isolated from other contact alarm outputs terminal mutually, but isolated from other input/output terminals and internal circuits.

RS-485 communication terminals:

Not isolated from contact input terminals, but isolated from other input/output terminals and internal circuits.

Feedback slidewire resistance input terminals:

Not isolated from control output terminals (current or voltage pulse) and retransmission output, but isolated from other input/output terminals and internal circuits.

Power terminals:

Isolated from other input/output terminals and internal circuits.

Ground terminal:

Isolated from other input/output terminals and internal circuits.

● Environmental Conditions**Normal operating conditions:**

Ambient temperature: 0 to 50°C (40°C or less in close mounting side-by-side)

Temperature change rate limit: 10°C /h or less

Ambient humidity: 20 to 90% RH (no condensation)

Magnetic field: 400 A/m or less

Continuous vibration (5 to 14 Hz):

Peak-to-peak amplitude 1.2 mm or less

Continuous vibration (14 to 150 Hz):

4.9 m/s² or less

Short period vibration: 14.7 m/s², 15 s or less

Shock: 147 m/s² or less, 11 ms

Installation altitude: 2000 m or less above sea level

Warm-up time: 30minutes or more

Transportation and storage conditions:

Temperature: -25 to 70°C

Temperature change rate limit: 20°C /h or less

Humidity: 5 to 95% RH (no condensation)

Effects of operating conditions**Effect of ambient temperature:**

Whichever is greater, $\pm 1 \mu\text{V}/^\circ\text{C}$ or $\pm 0.01\%$ of F.S./ $^\circ\text{C}$ for voltage or thermocouple inputs.

$\pm 0.02\%$ of F.S./ $^\circ\text{C}$ for remote input

$\pm 0.05^\circ\text{C}/^\circ\text{C}$ (ambient temperature) or less for RTD inputs.

$\pm 0.05\%$ of F.S./ $^\circ\text{C}$ or less for analog outputs.

Effect of power supply fluctuation (within rated voltage range):

Whichever is greater, $\pm 1 \mu\text{V}/10 \text{ V}$ or $\pm 0.01\%$ of F.S./10 V for remote inputs. $\pm 0.05\%$ of F.S./10 V or less for analog outputs.

Function Block Diagram for Standard Type

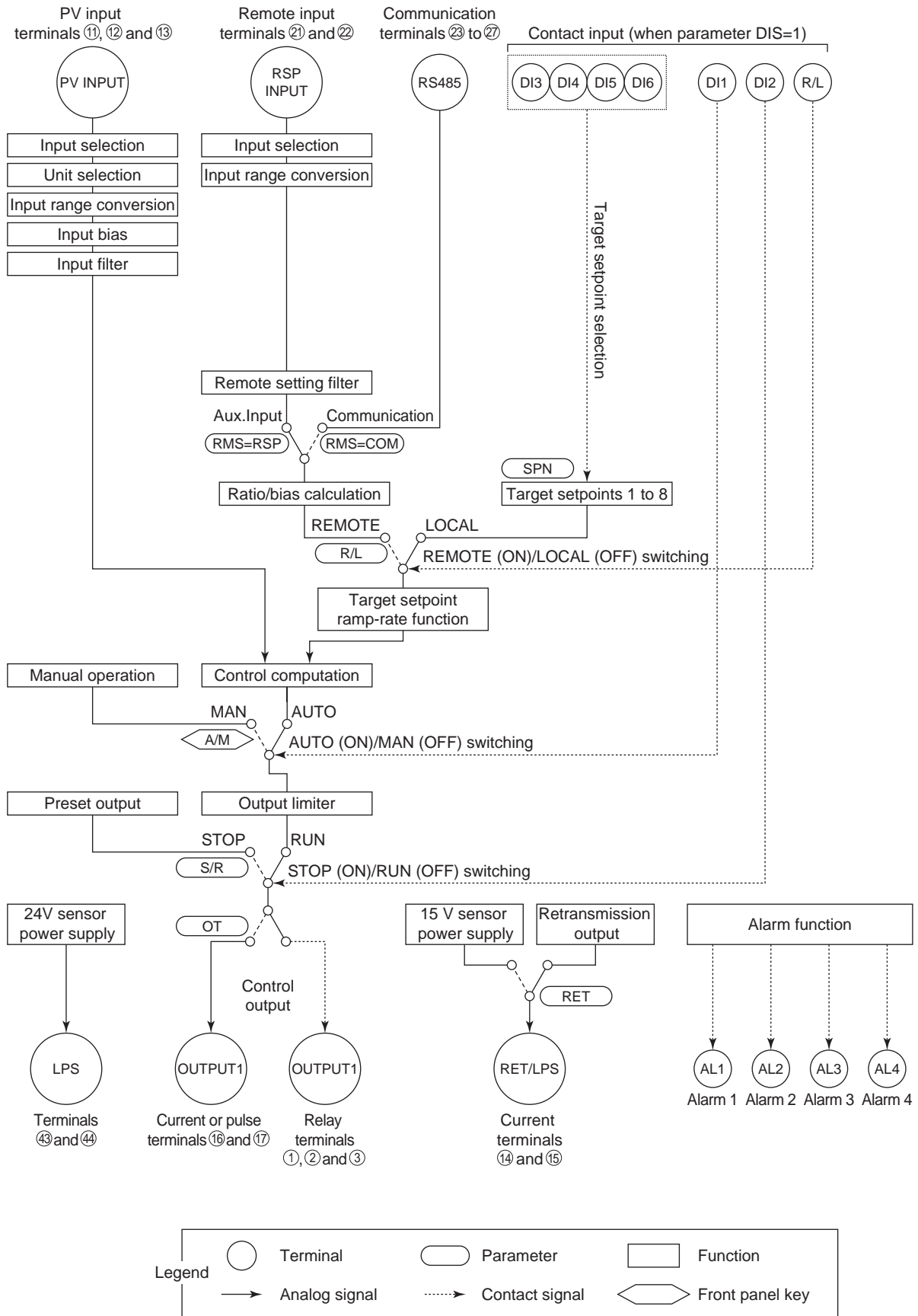

Function Block Diagram for Heating/Cooling Type

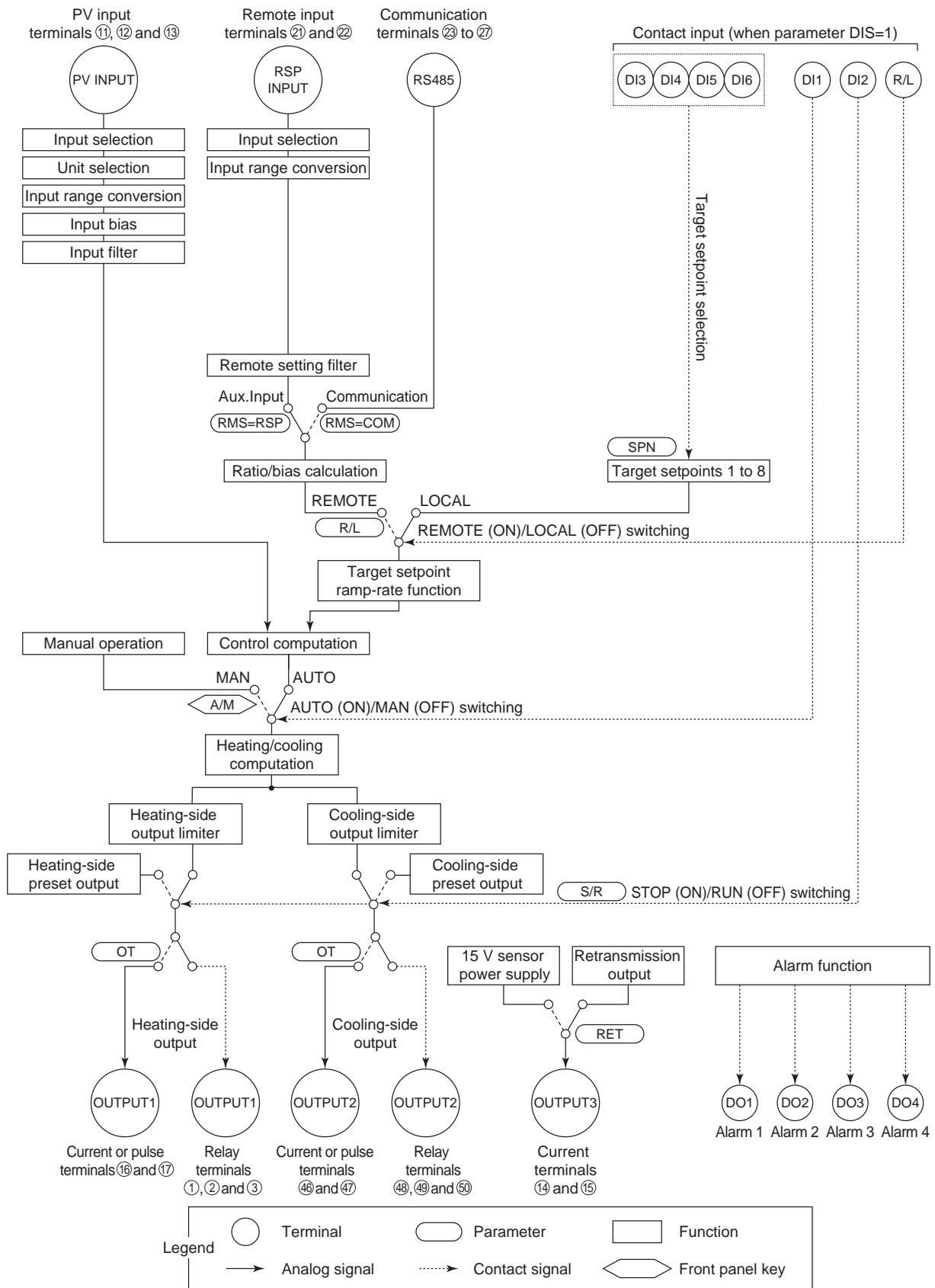

■ Function Block Diagram for Position Proportional Type

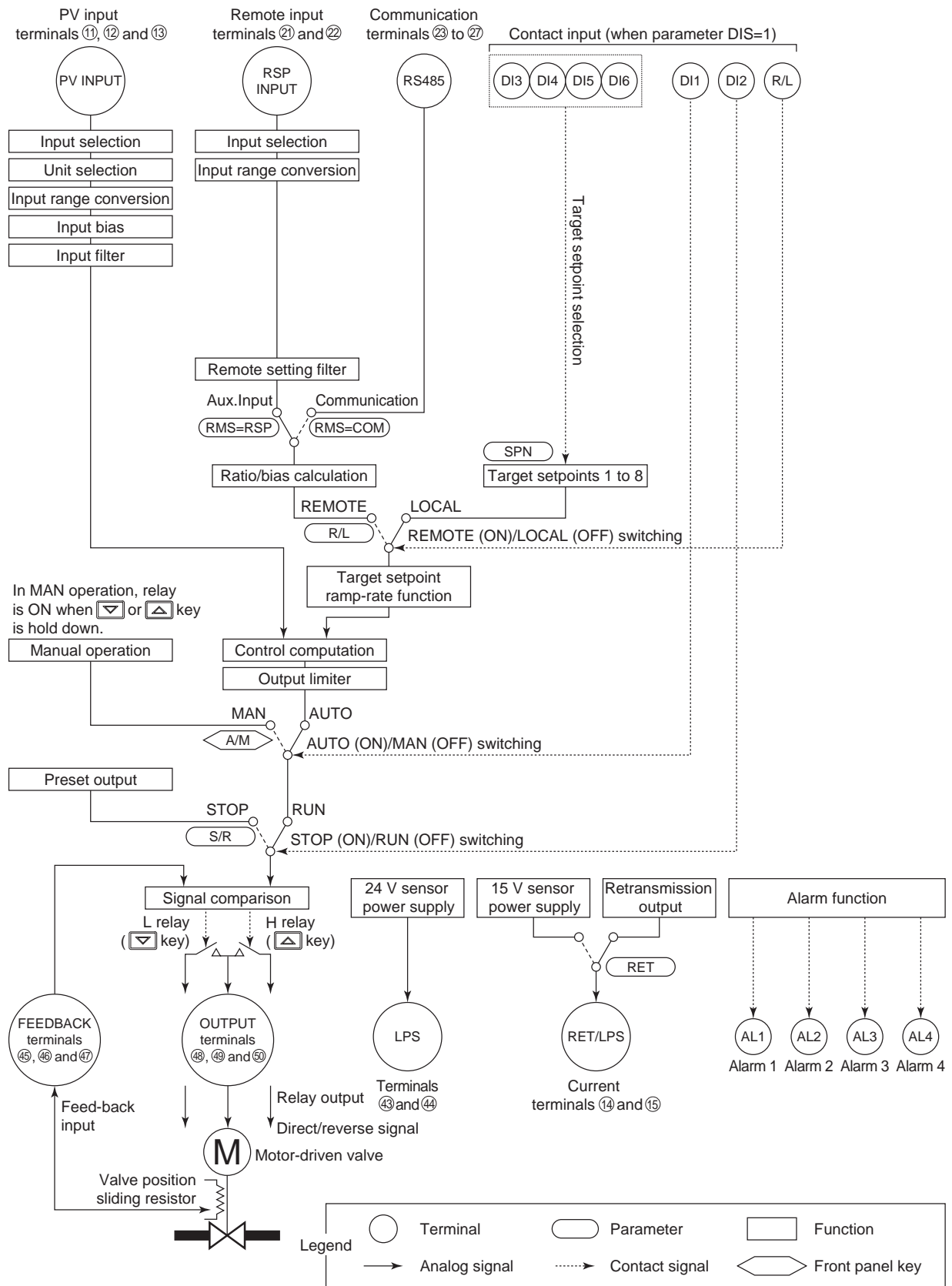

UT450 Standard Type (Model UT450-0□ or UT450-3□), Terminal Arrangements

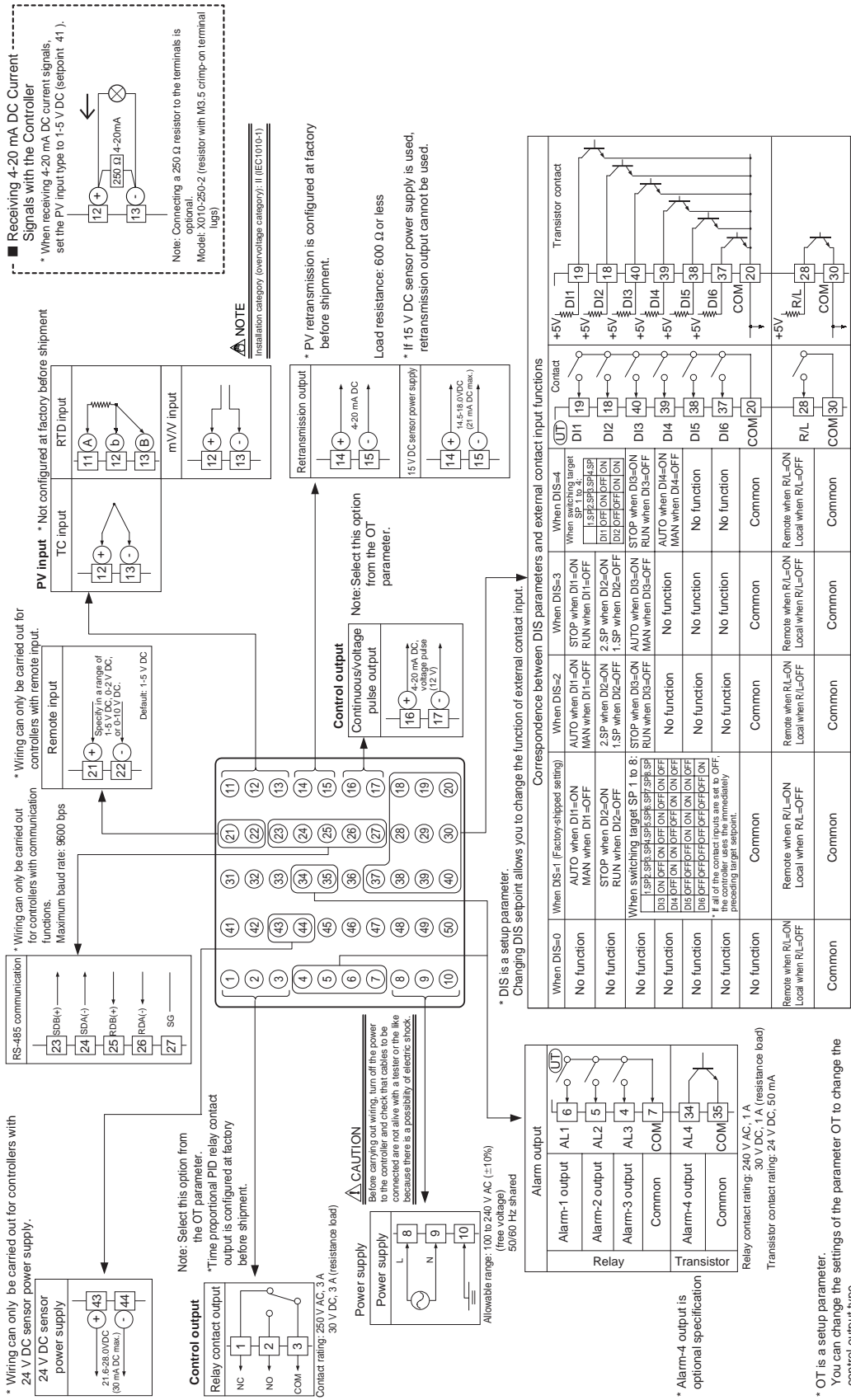

■ Receiving 4-20 mA DC Current Signals with the Controller
 * When receiving 4-20 mA DC current signals, set the PV input type to 1-5 V DC (setpoint: 41).

Note: Connecting a 250 Ω resistor to the terminals is optional.
 Model: X010-250-2 (resistor with M3.5 crimp-on terminal legs)

NOTE
 Installation category (overvoltage category): III (IEC1010-1)

* PV retransmission is configured at factory before shipment.
 Load resistance: 600 Ω or less
 * If 15 V DC sensor power supply is used, retransmission output cannot be used.

* DIS is a setup parameter.
 Changing DIS setpoint allows you to change the function of external contact input.

Correspondence between DIS parameters and external contact input functions

When DIS=0	When DIS=1 (Factory-shipped setting)	When DIS=2	When DIS=3	When DIS=4
No function	AUTO when DI1=ON MAN when DI1=OFF	AUTO when DI1=ON MAN when DI1=OFF	STOP when DI1=ON RUN when DI1=OFF	When DIS=4 target SP 1 to 4
No function	STOP when DI2=ON RUN when DI2=OFF	2.SP when DI2=ON 1.SP when DI2=OFF	2.SP when DI2=ON 1.SP when DI2=OFF	1.SP:SP1,SP2,SP3,SP4 DI1:DI1ON,DI1OFF DI2:DI2ON,DI2OFF
No function	No function	STOP when DIS=ON MAN when DIS=OFF	STOP when DIS=ON MAN when DIS=OFF	DI3:DI3ON,DI3OFF DI4:DI4ON,DI4OFF DI5:DI5ON,DI5OFF DI6:DI6ON,DI6OFF
No function	No function	No function	No function	DI3:SP1,SP2,SP3,SP4 DI4:DI4ON,DI4OFF DI5:DI5ON,DI5OFF DI6:DI6ON,DI6OFF
No function	No function	No function	No function	AUTO when DI4=ON MAN when DI4=OFF
No function	No function	No function	No function	No function
No function	No function	No function	No function	No function
Remote when RL=ON Local when RL=OFF	Common	Common	Common	Common
Common	Common	Common	Common	Common

* Alarm-4 output is optional specification

* OT is a setup parameter.
 You can change the settings of the parameter OT to change the control output type.

Correspondence between parameter OT and control output types

OT=0 (factory-set default)	OT=1	OT=2	OT=3
Time proportional control	Time proportional control	Current output (terminals ⑩ and ⑪)	On-off control
Relay output (terminals ①, ② and ③)	Voltage pulse output (terminals ⑩ and ⑪)	Relay output (terminals ⑩ and ⑪)	Relay output (terminals ①, ② and ③)

Note: External Contact Input if the power is turned on when the external contact input is OFF, the mode (SPN, R/L, or A/M) existing before the power is turned off will be continued. (except for RUN/STOP)

UT450 Heating/Cooling Type (Model UT450-2□)

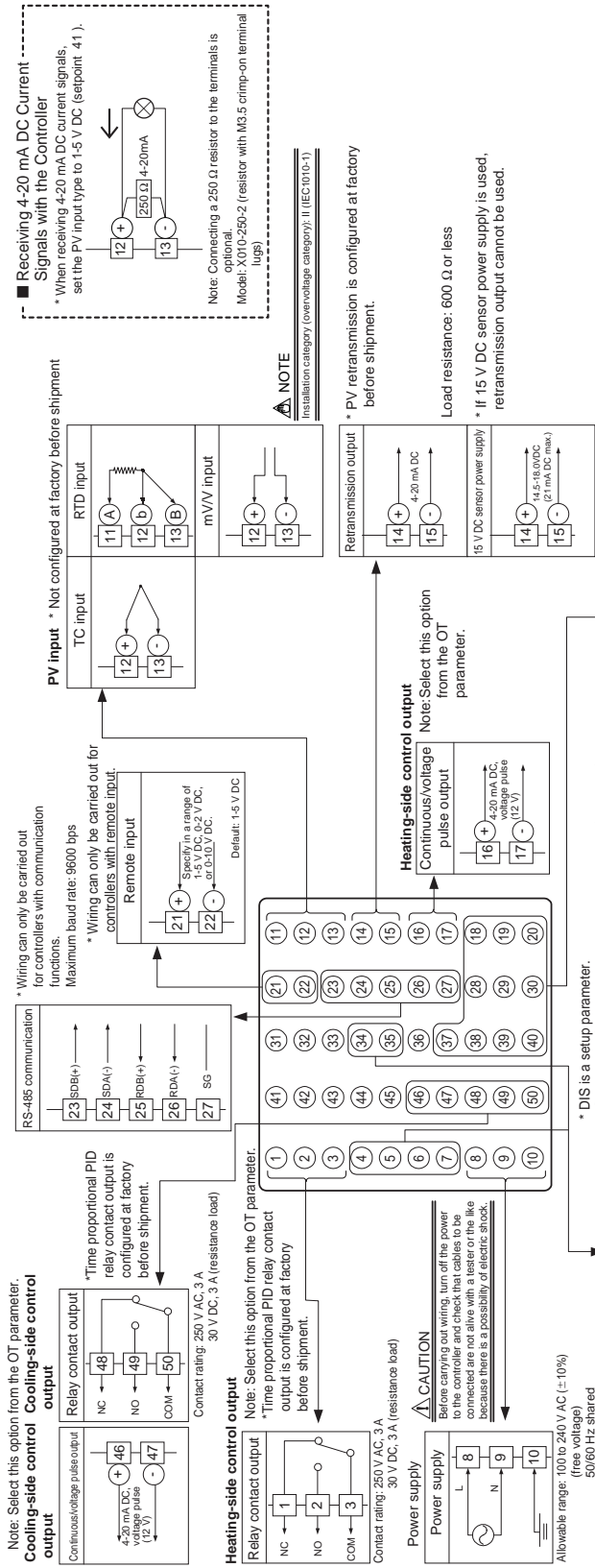

Correspondence between parameter DIS and external contact input functions

When DIS=0	When DIS=1 (Factory-shipped setting)	When DIS=2	When DIS=3	When DIS=4
No function	AUTO when DI1=ON MAN when DI1=OFF	AUTO when DI1=ON STOP when DI1=OFF	STOP when DI1=ON RUN when DI1=OFF	When switching target L.SP: SRS/SP/SP D1: OFF/ON/OFF/ON
No function	STOP when DI2=ON RUN when DI2=OFF	STOP when DI2=ON 2.SP when DI2=ON 1.SP when DI2=OFF	2.SP when DI2=ON 1.SP when DI2=OFF	D2: OFF/ON/OFF/ON
No function	No function	STOP when DI3=ON RUN when DI3=OFF	AUTO when DI3=ON MAN when DI3=OFF	D3: OFF/ON/OFF/ON
No function	No function	No function	No function	D4: OFF/ON/OFF/ON
No function	No function	No function	No function	D5: OFF/ON/OFF/ON
No function	No function	No function	No function	D6: OFF/ON/OFF/ON
No function	Common	Common	Common	COM
Remote when RL=ON Local when RL=OFF	Remote when RL=ON Local when RL=OFF	Remote when RL=ON Local when RL=OFF	Remote when RL=ON Local when RL=OFF	R/L
Common	Common	Common	Common	COM

Alarm output
 Terminals 6 (AL1), 7 (AL2), 4 (AL3), 34 (AL4), 35 (COM).
 Relay contact rating: 240 V AC, 1 A, 30 V DC, 1 A (resistance load).
 Transistor contact rating: 24 V DC, 50 mA.

Relay
 Terminals 19 (D1), 18 (D2), 40 (D3), 39 (D4), 38 (D5), 37 (D6), 20 (COM), 28 (R/L), 30 (COM).

Note: External Contact Input on when the external contact input is OFF, the mode (SPN, R/L, or AM) existing before the power is turned off will be continued. (except for RUN/STOP)

Correspondence between parameter OT and heating-side/cooling-side output types

OT=4 (factory-set default)	OT=5	OT=6	OT=7	OT=8	OT=9	OT=10	OT=11	OT=12
Heating side: Relay output (terminals 1, 2 and 3) Cooling side: Relay output (terminals 4 and 5)	Heating side: Voltage pulse output (terminals 16 and 17) Cooling side: Voltage pulse output (terminals 16 and 17)	Heating side: Current output (terminals 14 and 15) Cooling side: Current output (terminals 14 and 15)	Heating side: Relay output (terminals 1, 2 and 3) Cooling side: Voltage pulse output (terminals 16 and 17)	Heating side: Voltage pulse output (terminals 16 and 17) Cooling side: Voltage pulse output (terminals 16 and 17)	Heating side: Current output (terminals 14 and 15) Cooling side: Voltage pulse output (terminals 16 and 17)	Heating side: Relay output (terminals 1, 2 and 3) Cooling side: Current output (terminals 14 and 15)	Heating side: Voltage pulse output (terminals 16 and 17) Cooling side: Current output (terminals 14 and 15)	Heating side: Current output (terminals 14 and 15) Cooling side: Current output (terminals 14 and 15)

Note: The control output types, relay output, and voltage pulse output, shown in the table above refer to those of time proportional control. To change the type to a relay output for on-off control, select Relay Terminals and change the setpoint of the proportional band to 0.

UT450 Position Proportional Type (Model UT450-1□ or UT450-4□)

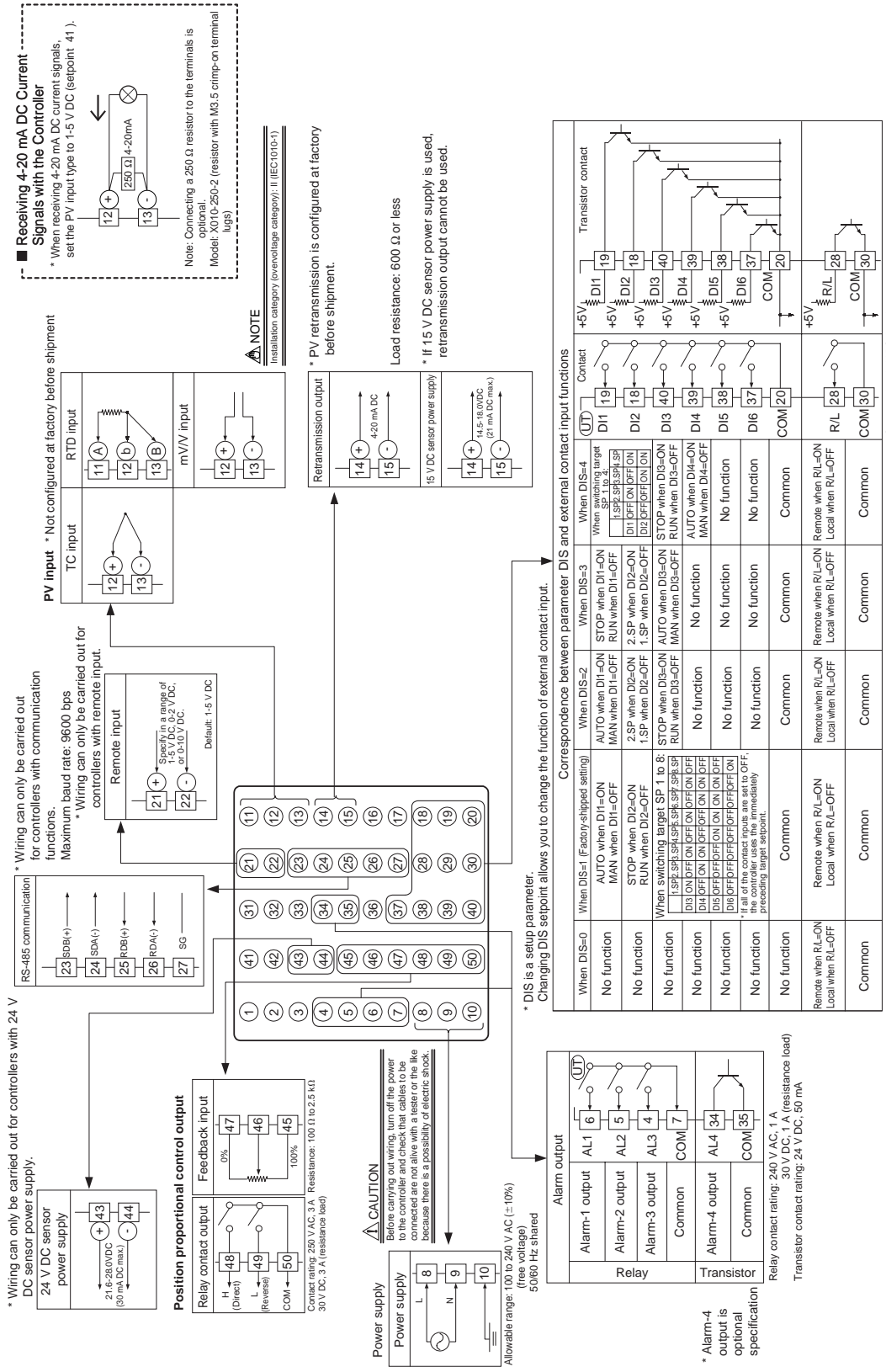

Correspondence between parameter DIS and external contact input functions

When DIS=0	When DIS=1 (Factory-shipped setting)	When DIS=2	When DIS=3	When DIS=4
When switching target SP 1 to 4: D1 OFF ON OFF ON D2 OFF OFF ON ON D3 OFF OFF ON ON D4 OFF OFF ON ON D5 OFF OFF ON ON D6 OFF OFF ON ON	AUTO when D1=ON MAN when D1=OFF	AUTO when D1=ON MAN when D1=OFF	STOP when D1=ON RUN when D1=OFF	When switching target SP 1 to 4: D1 OFF ON OFF ON D2 OFF OFF ON ON D3 OFF OFF ON ON D4 OFF OFF ON ON D5 OFF OFF ON ON D6 OFF OFF ON ON
No function	STOP when D2=ON RUN when D2=OFF	STOP when D2=ON RUN when D2=OFF	STOP when D2=ON RUN when D2=OFF	STOP when D2=ON RUN when D2=OFF
No function	STOP when D3=ON RUN when D3=OFF	STOP when D3=ON RUN when D3=OFF	STOP when D3=ON RUN when D3=OFF	STOP when D3=ON RUN when D3=OFF
No function	STOP when D4=ON MAN when D4=OFF	No function	No function	STOP when D4=ON MAN when D4=OFF
No function	No function	No function	No function	No function
No function	No function	No function	No function	No function
No function	No function	No function	No function	No function
No function	Common	Common	Common	Common
Remote when RL=ON Local when RL=OFF	Remote when RL=ON Local when RL=OFF	Remote when RL=ON Local when RL=OFF	Remote when RL=ON Local when RL=OFF	Remote when RL=ON Local when RL=OFF
Common	Common	Common	Common	Common

* DIS is a setup parameter.
 Changing DIS setpoint allows you to change the function of external contact input.

* If all of the contact inputs are set to OFF, the controller uses the immediately preceding target setpoint.

Note: External Contact Input
 If the power is turned on when the external contact input is OFF, the mode (SPN, R/L, or A/M) existing before the power is turned off will be continued.
 (except for RUN/STOP)

External Dimensions and Panel Cutout Dimensions

Unit: mm

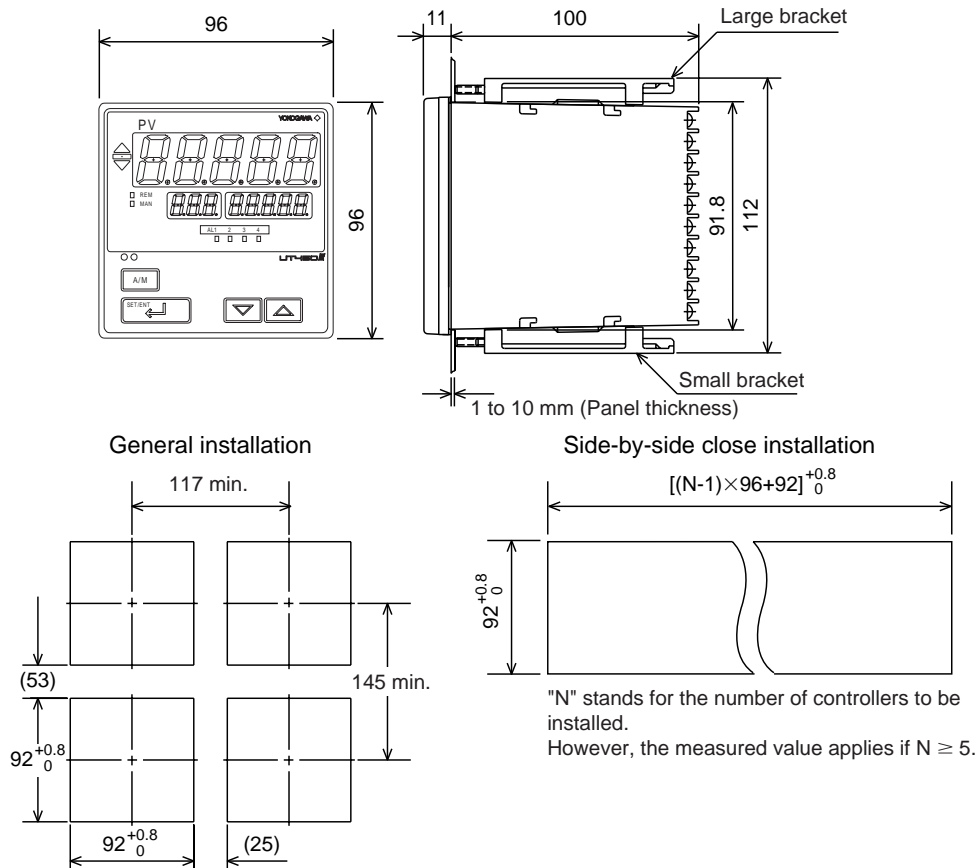

Model and Suffix Codes

Model	Suffix Code	Description
UT450		Digital indicating controller (provided with retransmission output and 15 V DC sensor power supply as standard)
Type	-0	Standard type
	-1	Position proportional type
	-2	Heating/cooling type
	-3	Standard type (with 24 V DC sensor power supply)
	-4	Position proportional type (with 24 V DC sensor power supply)
Optional functions	0	None
	1	With communication, remote input, 5 additional DIs, and 1 additional Alarm
	2	With communication, remote input, and 1 additional DI
	3	With 4 additional DIs and 1 additional Alarm
	4	With remote input and 1 additional DI

Standard accessories: Brackets (mounting hardware), unit label, User's Manuals, and User's Manual Reference (CD-ROM version).

Items to be Specified When Ordering

Model and suffix codes, necessary/unnecessary of User's Manual or QIC.