

---

**User's  
Manual**

**Models UT450/UT420  
Digital Indicating Controllers  
User's Manual**



IM 05D01C12-41E

---



# Introduction

Thank you for purchasing the UT450/UT420 digital indicating controller.

## ■ How to Use the Manuals

Purpose	Title	Description
Setup	1. Installation	Describes the tasks (installation, wiring, and others) required to make the controller ready for operations.
Basic operation	2. Initial Settings	Describes examples of setting PV input types, control output types, and alarm types. Making settings described herein allows you to carry out basic control.
Operating procedures and troubleshooting	3. Operations 4.1 Troubleshooting	Describes key operation sequences. For operation control through external contact inputs, see "1.5 Terminal Wiring Diagrams."
Brief operation and setpoint recording	5. Parameters	Contains the parameter map used as a guideline for setting parameters and lists of parameters for recording User Settings.

## ■ Regarding This User's Manual

- (1) This manual should be provided to the end user. Keep an extra copy or copies of the manual in a safe place.
- (2) Read this manual carefully to gain a thorough understanding of how to operate this product before starting operation.
- (3) This manual describes the functions of this product. Yokogawa Electric Corporation (hereinafter simply referred to as Yokogawa) does not guarantee the application of these functions for any particular purpose.
- (4) Under absolutely no circumstances may the contents of this manual, in part or in whole, be transcribed or copied without permission.
- (5) The contents of this manual are subject to change without prior notice.
- (6) Every effort has been made to ensure that the details of this manual are accurate. However, should any errors be found or important information be omitted, please contact your nearest Yokogawa representative or our sales office.

## ■ Safety Precautions

The following symbol is indicated on the controller to ensure safe use.



This symbol on the controller indicates that the operator must refer to an explanation in the user's manual in order to avoid the risk of injury or death of personnel or damage to the instrument. The manual describes how the operator should exercise special care to avoid electric shock or other dangers that may result in injury or loss of life.

---

The following symbols are used in the hardcopy user's manuals and in the user's manual supplied on the CD-ROM.



Indicates that operating the hardware or software in a particular manner may damage it or result in a system failure.

---



Draws attention to information that is essential for understanding the operation and/or features of the controller.

---

## ■ Force Majeure

- (1) Yokogawa assumes no liability to any party for any loss or damage, direct or indirect, caused by the use or any unpredictable defect of the product.
- (2) No portion of the software supplied by Yokogawa may be transferred, exchanged, leased or sublet for use by any third party without the prior permission of Yokogawa.
- (3) Be sure to use the spare parts approved by Yokogawa when replacing parts or consumables.
- (4) Use this software with one specified computer only. You must purchase another copy of the software for use on each additional computer.
- (5) Copying this software for purposes other than backup is strictly prohibited.
- (6) Store the floppy disk(s) (original medium or media) containing this software in a secure place.

---

## ■ Regarding Protection, Safety, and Prohibition Against Unauthorized Modification

- (1) In order to protect the product and the system controlled by it against damage and ensure its safe use, make certain that all of the instructions and precautions relating to safety contained in this document are strictly adhered to. Yokogawa does not guarantee safety if products are not handled according to these instructions.
- (2) Modification of the product is strictly prohibited.
- (3) Reverse engineering such as the disassembly or decompilation of software is strictly prohibited.

---

Blank Page

# Models UT450/UT420 Digital Indicating Controllers User's Manual

IM 05D01C12-41E 4th Edition

## CONTENTS

Introduction .....	i
<b>1. Installation .....</b>	<b>1-1</b>
1.1 Model and Suffix Codes .....	1-1
1.2 How to Install .....	1-2
1.3 How to Connect Wires .....	1-5
1.4 Hardware Specifications .....	1-7
1.5 Terminal Wiring Diagrams .....	1-14
<b>2. Initial Settings .....</b>	<b>2-1</b>
2.1 Names and Functions of Front Panel Parts .....	2-2
2.2 Setting PV Input Type (Setting First at Power-on) .....	2-3
2.3 Changing PV Input Type .....	2-7
2.4 Setting Control Output Type (except for a Position Proportional Controller) ...	2-9
2.5 Calibrating Valve Position (for a Position Proportional Controller Only) ...	2-11
2.6 Initializing Parameters .....	2-12
2.7 Changing Alarm Type .....	2-13
2.8 Description of Multiple Setpoints and PID .....	2-16
<b>3. Operations .....</b>	<b>3-1</b>
3.1 Monitoring-purpose Operating Displays Available during Operation .....	3-1
3.2 Setting Target Setpoint (SP) .....	3-3
3.3 Performing/Canceling Auto-tuning .....	3-3
3.4 Setting PID Manually .....	3-5
3.5 Setting Alarm Setpoints .....	3-6
3.6 Selecting Target Setpoint Numbers (SPN) .....	3-7
3.7 Switching between Run and Stop .....	3-8
3.8 Switching between AUTO and MAN .....	3-9
3.9 Manipulating Control Output during Manual Operation .....	3-10
3.10 Switching between Remote (REM) and Local (LCL) .....	3-12

---

<b>4.</b>	<b>Troubleshooting and Maintenance .....</b>	<b>4-1</b>
4.1	<b>Troubleshooting .....</b>	<b>4-1</b>
4.2	<b>Maintenance .....</b>	<b>4-6</b>
4.2.1	Cleaning .....	4-6
4.2.2	Replacing Brackets .....	4-6
4.2.3	Attaching Terminal Cover .....	4-7
4.2.4	Replacing Parts with a Limited Service Life .....	4-8
4.2.5	Replacing Control Output Relays .....	4-9
<b>5.</b>	<b>Parameters .....</b>	<b>5-1</b>
5.1	Parameter Map .....	5-1
5.2	Lists of Parameters .....	5-6
<b>6.</b>	<b>Function Block Diagram and Descriptions .....</b>	<b>6-1</b>
	<b>Revision Information .....</b>	<b>i</b>



# 1. Installation

This chapter describes installation, wiring, and other tasks required to make the controller ready for operation.

## 1.1 Model and Suffix Codes

Before using the controller, check that the model and suffix codes match your order.

Model	Suffix Code	Description
UT450		Digital indicating controller (provided with retransmission output and 15 V DC loop power supply as standard)
Type	-0	Standard type
	-1	Position proportional type
	-2	Heating/cooling type
	-3	Standard type (with 24 V DC loop power supply)
	-4	Position proportional type (with 24 V DC loop power supply)
Optional functions	0	None
	1	With communication, remote input, 5 additional DIs, and 1 additional Alarm
	2	With communication, remote input, and 1 additional DI
	3	With 4 additional DIs and 1 additional Alarm
	4	With remote input and 1 additional DI

Model	Suffix Code	Description
UT420		Digital indicating controller (provided with retransmission output and 15 V DC loop power supply as standard)
Type	-0	Standard type
Optional functions	0	None
	7	With communication, remote input, and 2 additional DIs
	8	With remote input and 2 additional DIs

Check that the following items are provided:

- Digital indicating controller (of ordered model) ..... 1
- Brackets (mounting hardware) ..... 1 pair
- Unit label ..... 1
- User's Manuals ..... 4 (A2 size)
- User's Manual (Reference) (CD-ROM version) ..... 1

### ■ Correspondence between the Model and Suffix Codes, and the Contact Input/Output Terminals Provided

Check the model ordered and the presence/absence of contact inputs and outputs in the following table.

✓ indicate that the contacts are available.

Model and Suffix Codes	Contact input terminals							Alarm output terminals			
	DI1	DI2	DI3	DI4	DI5	DI6	R/L	AL1	AL2	AL3	AL4
UT450-□0	✓	✓						✓	✓	✓	
UT450-□1	✓	✓	✓	✓	✓	✓	✓	✓	✓	✓	✓
UT450-□2	✓	✓						✓	✓	✓	
UT450-□3	✓	✓	✓	✓	✓	✓		✓	✓	✓	✓
UT450-□4	✓	✓					✓	✓	✓	✓	
UT420-00	✓	✓						✓	✓	✓	
UT420-07	✓	✓	✓				✓	✓	✓	✓	
UT420-08	✓	✓	✓				✓	✓	✓	✓	

Note: For the contact input functions, see "1.5 Terminal Wiring Diagrams."

# 1.2 How to Install

## NOTE

To install the controller, select a location where:

1. no one may accidentally touch the terminals,
2. mechanical vibrations are minimal,
3. corrosive gas is minimal,
4. temperature can be maintained at about 23°C and the fluctuation is minimal,
5. no direct radiant heat is present,
6. no magnetic disturbances are caused,
7. no wind blows against the terminal board (reference junction compensation element),
8. no water is splashed,
9. no flammable materials are around,

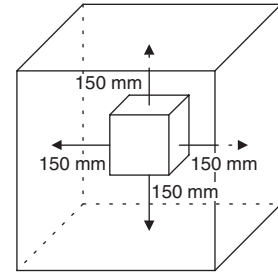

Never place the controller directly on flammable items or equipment.

If the controller has to be installed close to flammable items or equipment, be sure to provide shielding panels all around the controller, at least 150 mm away from every side; the panels should be made of either 1.43 mm-thick metal-plated steel plates or 1.6 mm-thick uncoated steel plates.

### ● Installation Position

Install the controller at an angle within 30° from horizontal with the front panel facing upward. Do not install it facing downward. The position of right and left sides should be horizontal.

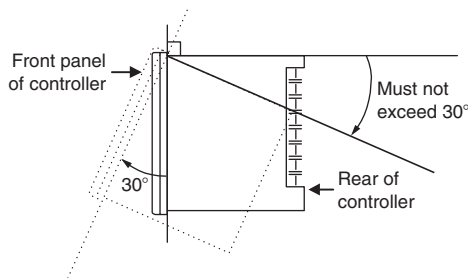

## External Dimensions and Panel Cutout Dimensions

UT450

Unit: mm

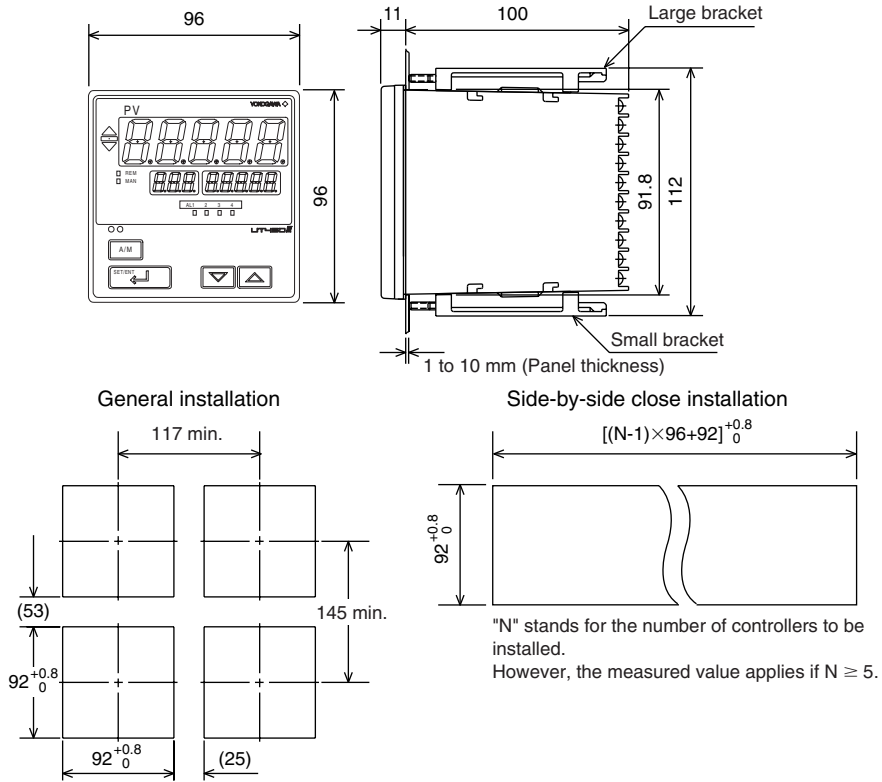

UT420

Unit: mm

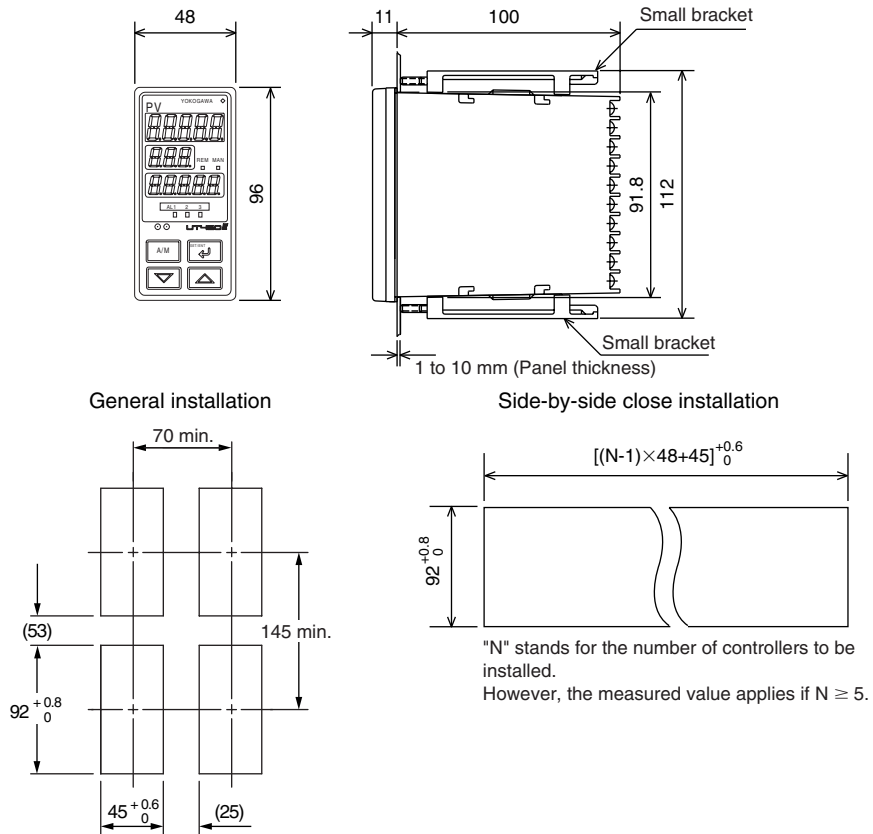

## ■ How to Install



### CAUTION

Turn off the power to the controller before installing it on the panel because there is a possibility of electric shock.

After opening the mounting hole on the panel, follow the procedures below to install the controller:

1. Insert the controller into the opening from the front of the panel so that the terminal board on the rear is at the far side.
2. Set the brackets in place on the top and bottom of the controller as shown in the figure below, then tighten the screws of the brackets. Take care not to overtighten them.

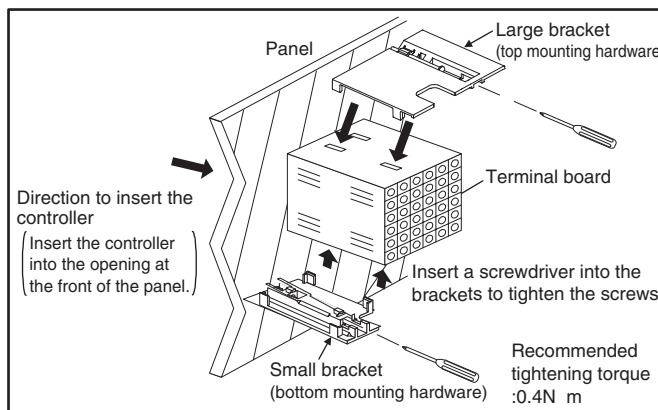

# 1.3 How to Connect Wires



- 1) Before carrying out wiring, turn off the power to the controller and check that the cables to be connected are not alive with a tester or the like because there is a possibility of electric shock.
- 2) For the protection and safe use of the controller, be sure to place a circuit breaker (conforms with IEC60947, 5A, 100V or 220V AC) near the controller where the breaker can easily be operated. In addition, be sure to indicated that it is the instrument to cut the power supply of the controller.
- 3) Wiring must be carried out by personnel who have basic electrical knowledge and practical experience.



- 1) Provide power from a single-phase instrument power supply. If there is a lot of noise in the power line, insert an insulating transformer into the primary side of the line and use a line filter (recommended part: ZAC2205-00U from TDK) on the secondary side. As a countermeasures against noise, do not place the primary and secondary power cables close to each other.
- 2) For thermocouple input, use shielded compensating lead wires for wiring. For RTD input, use shielded wires that have low conductor resistance and cause no significant differences in resistance between the three wires. The cables to be used for wiring, terminal specifications, and recommended parts are as shown below.
- 3) Control output relays may be replaced. However, because they have a life of 100,000 times that of the resistance load, use auxiliary relays to turn on/off a load.
- 4) The use of inductance (L) loads such as auxiliary relays, motors and solenoid valves causes malfunction or relay failure; always insert a CR filter for use with alternating current or a diode for use with direct current, as a spark-removal surge suppression circuit, into the line in parallel with the load.
- 5) When there is possibility of being struck by external lightening surge, use the arrester to protect the instrument.

### ■ For DC Relay Wiring

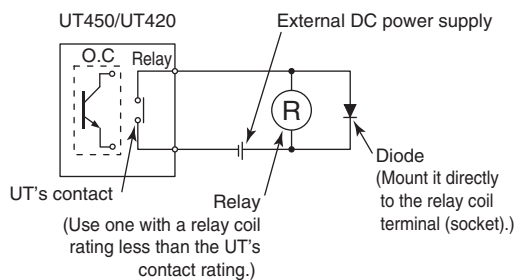

### ■ For AC Relay Wiring

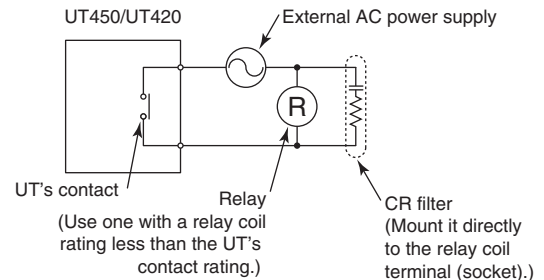

### ● Cable Specifications and Recommended Cables

Purpose	Name and Manufacturer
Power supply, grounding, relay contact outputs	600 V PVC insulated wires, JIS C 3307, 0.9 to 2.0 mm <sup>2</sup>
Thermocouple	Shielded compensating lead wires, JIS C 1610, □X-□-□-□ (See Yokogawa Electric's GS 6B1U1-E.)
RTD	Shielded wires (three conductors), UL2482 (Hitachi Cable)
Other signals	Shielded wires

### ● Recommended Terminal Lugs

Applicable wire size	Tightening torque
0.3 to 1.65 mm <sup>2</sup>	0.8 N·m or less

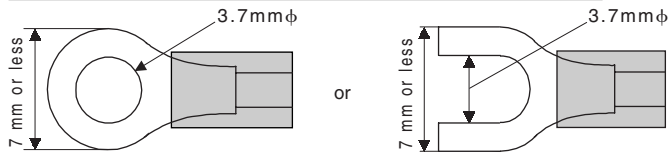

### ● Terminal Covers

Target Model	Part Number	Sales Unit
For UT450	T9115YD	1
For UT420	T9115YE	1

## 1.4 Hardware Specifications

### PV Input Signals

- Number of inputs: 1 (terminals ⑪-⑫-⑬)
- Input type: Universal input system. The input type can be selected with the software.
- Sampling period: 200 ms
- Burnout detection: Functions at TC, RTD, standard signal (0.4 to 2 V or 1 to 5 V)  
Upscale, downscale, and off can be specified.  
For standard signal, burnout is determined to have occurred if it is 0.1 V or less.
- Input bias current: 0.05  $\mu$ A (for TC or RTD b-terminal)
- Measurement current (RTD): About 0.13 mA
- Input resistance: 1 M $\Omega$  or more for thermocouple or mV input  
About 1 M $\Omega$  for DC voltage input
- Allowable signal source resistance: 250  $\Omega$  or less for thermocouple or mV input  
Effects of signal source resistance: 0.1  $\mu$ V/ $\Omega$  or less  
2 k $\Omega$  or less for DC voltage input  
Effects of signal source resistance: About 0.01%/100  $\Omega$
- Allowable wiring resistance: for RTD input  
Maximum 150  $\Omega$  /wire: Conductor resistance between three wires should be equal  
However, 10  $\Omega$  /wire for a maximum range of -150.0 to 150.0°C.  
Wire resistance effect:  $\pm$ 0.1°C/10  $\Omega$
- Allowable input voltage:  $\pm$ 10 V DC for thermocouple, mV, or RTD input  
 $\pm$ 20 V DC for DC voltage input
- Noise rejection ratio: 40 dB (50/60 Hz) or more in normal mode  
120 dB (50/60 Hz) or more in common mode
- Reference junction compensation error:  $\pm$ 1.0°C (15 to 35°C)  
 $\pm$ 1.5°C (0 to 15°C, 35 to 50°C)
- Applicable standards: JIS, IEC, DIN (ITS-90) for thermocouples and RTD

### Remote Input Signals

Available only for controllers with remote input terminals.

- Number of inputs: 1 (terminals ⑳-㉑)
- Input type: Settable in a range of 0-2, 0-10, 0.4-2.0, or 1-5 V DC
- Sampling period: 200 ms
- Input resistance: About 1 M $\Omega$
- Input accuracy:  $\pm$ 0.3%  $\pm$ 1 digit of input span for 0 to 2 V DC  
 $\pm$ 0.2%  $\pm$ 1 digit of input span for 0 to 10 V DC  
 $\pm$ 0.375%  $\pm$ 1 digit of input span for 0.4 to 2.0 V DC  
 $\pm$ 0.3%  $\pm$ 1 digit of input span for 1 to 5 V DC  
Under standard operating conditions (23 $\pm$ 2°C, 55 $\pm$ 10% RH, power frequency of 50/60 Hz)

### Feedback Resistance Input

Provided for position proportional type only (terminals ④⑤-④⑥-④⑦)

- Slide resistance value: 100 Ω to 2.5 kΩ of overall resistance (burnout detection for sliding wire provided)
- Measuring resolution: ±0.1% of overall resistance

### Loop Power Supply

Power is supplied to a two-wire transmitter.

(15 V DC: terminals ①④-①⑤; 24 V DC: terminals ④③-④④)

A resistor (10 to 250 Ω) connected between the controller and transmitter converts a current signal into a voltage signal, which is then read via the PV input terminal.

Supply voltage: 14.5 to 18.0 V DC, max. 21 mA (provided with a protection circuit against a field short-circuit); 21.6 to 28.0 V DC, max. 30 mA (only for models with 24 V DC loop power supply)

### Retransmission Output

Either PV, target setpoint, or control output is output.

Either the retransmission output or the loop power supply can be used with terminals ①④-①⑤.

- Number of outputs: 1 (terminals ①④-①⑤)
- Output signal: 4-20 mA DC
- Load resistance: 600 Ω or less
- Output accuracy: ±0.1% of span (±5% of span for 1 mA or less.)  
Under standard operating conditions (23±2°C, 55±10% RH, power frequency of 50/60 Hz)

### Control Output

Universal output system. The output type can be selected with the software.

Relay contact output(s) for the position proportional type

- Current output  
(Standard type: terminals ①⑥-①⑦; heating-side: terminals ①⑥-①⑦, cooling-side: terminals ④⑥-④⑦)

Number of outputs	1 or 2 (two for heating/cooling type), switched between a voltage pulse output and current output.
Output signal	4-20 mA DC
Load resistance	600 Ω or less
Output accuracy	±0.1% of span Under standard operating conditions (23±2°C, 55±10% RH, power frequency of 50/60 Hz)

- Voltage pulse output  
(Standard type: terminals ①⑥-①⑦; heating-side: terminals ①⑥-①⑦, cooling-side: terminals ④⑥-④⑦)

Number of outputs	1 or 2 (two for heating/cooling type), switched between a voltage pulse output and current output.
Output signal	On-voltage = 12 V or more (load resistance: 600 Ω or more) Off-voltage = 0.1 V DC or less
Resolution	10 ms or 0.1% of output, whichever is larger



- Relay contact output  
(Standard type: terminals ①-②-③, heating-side: terminals ①-②-③, cooling-side: terminals ④⑧-④⑨-⑤⑩, position proportional type: terminals ④⑧-④⑨-⑤⑩)

Number of outputs	1 or 2 (two for heating/cooling type)
Output signal	Three terminals (NC, NO, and common)
Contact rating	250 V AC or 30 V DC, 3 A (resistance load)
Resolution	10 ms or 0.1% of output, whichever is larger

### Contact Inputs

- Purpose: Target setpoint selection, remote/local mode switching, and run/stop switching
- Number of inputs: Differs with model and suffix codes as shown in the table below.

Model and Suffix Codes	Number of Inputs
UT450-□0	2
UT450-□1	7
UT450-□2	3
UT450-□3	6
UT450-□4	3
UT420-00	2
UT420-07	4
UT420-08	4

- Input type: Non-voltage contact or transistor open collector input
- Input contact rating: 12 V DC, 10 mA or more
- On/off determination: For non-voltage contact input, contact resistance of 1 kΩ or less is determined as “on” and contact resistance of 20 kΩ or more as “off.”  
For transistor open collector input, input voltage of 2 V or less is determined as “on” and leakage current must not exceed 100 μA when “off.”
- Minimum status detection hold time: 0.6 second

### Contact Outputs

- Purpose: Alarm output, FAIL output, and others
- Number of outputs: Differs with the model and suffix code as shown in the table below.

Model and Suffix Codes	Number of Outputs
UT450-□0	3
UT450-□1	4
UT450-□2	3
UT450-□3	4
UT450-□4	3
UT420-00	3
UT420-07	3
UT420-08	3

- Relay contact rating: 240 V AC, 1 A, or 30 V DC, 1 A
- Transistor contact rating: 24 V DC, 50 mA

### Display Specifications

- PV display:  
 UT450 — 5-digit, 7-segment, red LEDs, character height of 20 mm  
 UT420 — 5-digit, 7-segment, red LEDs, character height of 12 mm
- Setpoint display: 3-digit and 5-digit, 7-segment, red LEDs, character height of 9.3 mm (for both UT450 and UT420)
- Status indicating lamps: LEDs

### Safety and EMC Standards

- Safety: Complies with IEC/EN61010-1 (CE), approved by C22.2 No.61010-1, approved by UL508.  
 Installation category : CAT. II Pollution degree : 2 (IEC/EN61010-1, C22.2 No.61010-1)  
 Measurement category : I (CAT. I : IEC/EN61010-1)  
 Rated measurement input voltage : 10V DC max.(across terminals), 300V AC max.(across ground)  
 Rated transient overvoltage : 1500V (Note)  
 Note : It is a value on the safety standard which is assumed by IEC/EN61010-1 in Measurement category I, and is not the value which guarantees an apparatus performance.



This equipment has Measurement category I, therefore do not use the equipment for measurements within Measurement categories II, III and IV.

Measurement category		Description	Remarks
I	CAT. I	For measurements performed on circuits not directly connected to MAINS.	
II	CAT. II	For measurements performed on circuits directly connected to the low voltage installation.	Appliances, portable equipments, etc.
III	CAT. III	For measurements performed in the building installation.	Distribution board, circuit breaker, etc.
IV	CAT. IV	For measurements performed at the source of the low-voltage installation.	Overhead wire, cable systems, etc.

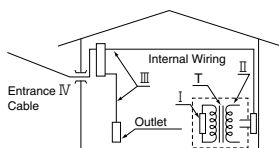

- EMC standards: Complies with EN61326, EN61000-3-2, EN61000-3-3 and EN55011 (CE).  
 AS/NZS 2064 compliant (C-Tick).  
 Class A Group 1.  
 The instrument continues to operate at a measuring accuracy of within  $\pm 20\%$  of the range during tests.

## Construction, Installation, and Wiring

- Construction: Dust-proof and drip-proof front panel conforming to IP55. For side-by-side close installation the controller loses its dust-proof and drip-proof protection.
- Material: ABS resin and polycarbonate
- Case color: Black
- Weight: About 1 kg or less
- Dimensions:  
UT450 — 96 (W) × 96 (H) × 100 (depth from panel face) mm  
UT420 — 48 (W) × 96 (H) × 100 (depth from panel face) mm
- Installation: Panel-mounting type. With top and bottom mounting hardware (1 each)
- Panel cutout dimensions:  
UT450 —  $92_{0}^{+0.8}$  (W) ×  $92_{0}^{+0.8}$  (H) mm  
UT420 —  $45_{0}^{+0.6}$  (W) ×  $92_{0}^{+0.8}$  (H) mm
- Installation position: Up to 30° upward facing (not designed for facing downward)
- Wiring: M3.5 screw terminals (for signal wiring and power/ground wiring as well)

## Power Supply Specifications

- Power supply: Rated voltage of 100 to 240 V AC ( $\pm 10\%$ ), 50/60 Hz
- Power consumption: Max. 20 VA (8.0 W max.)
- Internal fuse rating: 250 V AC, 1.6A time-lag fuse
- Data backup: Non-volatile memory (can be written to up to 100,000 times)
- Withstanding voltage
  - Between primary terminals\* and secondary terminals\*\*:  
At least 1500 V AC for 1 minute
  - Between primary terminals\* and grounding terminal:  
At least 1500 V AC for 1 minute
  - Between grounding terminal and secondary terminals\*\*:  
At least 1500 V AC for 1 minute
  - Between secondary terminals\*\*:  
At least 500 V AC for 1 minute
- \* Primary terminals indicate power terminals and relay output terminals
- \*\* Secondary terminals indicate analog I/O signal, voltage pulse output, and contact input terminals
- Insulation resistance: 20 M $\Omega$  or more at 500 V DC between power terminals and grounding terminal
- Grounding: Class D grounding (grounding resistance of 100  $\Omega$  or less)

## Signal Isolations

- PV input terminals: Isolated from other input/output terminals. Not isolated from the internal circuit.
- Remote input terminals: Isolated from other input/output terminals and the internal circuit.
- 15 V DC loop power supply terminals: Not isolated from 4-20 mA analog output nor voltage pulse control output. Isolated from other input/output terminals and internal circuit.
- 24 V DC loop power supply terminals: Isolated from 15 V DC loop power supply terminals, 4-20 mA analog output terminals, voltage pulse control output terminals, other input/output terminals and the internal circuit.
- 4-20 mA analog output terminals (for control output and retransmission): Not isolated between 4-20 mA outputs nor from 15 V DC loop power supply and voltage pulse control output. Isolated from other input/output terminals and internal circuit.
- Voltage pulse control output terminals: Not isolated from 4-20 mA outputs nor 15 V DC loop power supply. Isolated from other input/output terminals and internal circuit.
- Relay contact control output terminals: Isolated between contact output terminals and from other input/output terminals and internal circuit.
- Contact input terminals: Not isolated between contact input terminals and from communication terminals. Isolated from other input/output terminals and internal circuit.
- Relay contact alarm output terminals: Not isolated between relay contact alarm outputs. Isolated from other input/output terminals and internal circuit.
- Transistor contact alarm output terminals: Not isolated between transistor contact alarm outputs. Isolated from other input/output terminals and internal circuit.
- RS-485 communication terminals: Not isolated from contact input terminals. Isolated from other input/output terminals and internal circuit.
- Feedback slide resistance input terminals: Not isolated from 4-20 mA analog output terminals (control, retransmission), 15 V DC loop power supply, and voltage pulse control outputs. Isolated from other input/output terminals and internal circuit.
- Power terminals: Isolated from other input/output terminals and internal circuit.
- Grounding terminals: Isolated from other input/output terminals and internal circuit.

## Environmental Conditions

- Normal operating conditions:
  - Ambient temperature: 0 to 50°C (40°C or less for side-by-side close installation)
  - Temperature change rate: 10°C/h or less
  - Ambient humidity: 20 to 90% RH (no condensation allowed)
  - Magnetic field: 400 A/m or less
  - Continuous vibration at 5 to 14 Hz: Full amplitude of 1.2 mm or less
  - Continuous vibration at 14 to 150 Hz: 4.9 m/s<sup>2</sup> or less
  - Short-period vibration: 14.7 m/s<sup>2</sup>, 15 seconds or less
  - Shock: 147 m/s<sup>2</sup> or less, 11 ms
  - Installation height: Height above sea level of 2000 m or less
  - Warm-up time: 30 minutes or more after power on
- Transportation and storage conditions:
  - Temperature: -25 to 70°C
  - Temperature change rate: 20°C/h or less
  - Humidity: 5 to 95% RH (no condensation allowed)
- Effects of changes in operating conditions
  - Effects from changes in ambient temperature:
    - On voltage or thermocouple input,  $\pm 1 \mu\text{V}/^\circ\text{C}$  or  $\pm 0.01\%$  of F.S./ $^\circ\text{C}$ , whichever is larger
    - On remote input,  $\pm 0.02\%$  of F.S./ $^\circ\text{C}$
    - On RTD input,  $\pm 0.05^\circ\text{C}/^\circ\text{C}$  (ambient temperature) or less
    - On analog output,  $\pm 0.05\%$  of F.S./ $^\circ\text{C}$  or less
  - Effects from power supply fluctuation (within rated voltage range)
    - On remote input,  $\pm 1 \mu\text{V}/10 \text{ V}$  or  $\pm 0.01\%$  of F.S./10 V, whichever is larger
    - On analog output,  $\pm 0.05\%$  of F.S./10 V or less

## 1.5 Terminal Wiring Diagrams



### NOTE

---

Do not use unassigned terminals as relay terminals.

---

Terminal wiring diagrams are shown on and after the next page.

# ■ UT450 Standard Type (Model UT450-0□ or UT450-3□) or Heating/Cooling Type (Model UT450-2□)

\* Wiring can only be carried out for controllers with 24 V DC loop power supply.

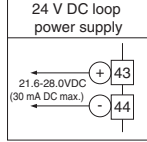

### Control output

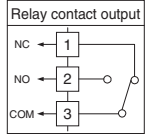

Contact rating: 250 V AC, 3 A  
30 V DC, 3 A (resistance load)

Note: Select this option from the OT parameter.  
\*Time proportional PID relay contact output is configured at factory before shipment.

### Power supply

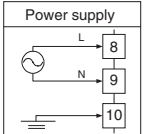

Allowable range: 100 to 240 V AC (±10%)  
(free voltage)  
50/60 Hz shared

**CAUTION**  
Before carrying out wiring, turn off the power to the controller and check that cables to be connected are not alive with a tester or the like because there is a possibility of electric shock.

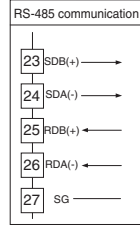

\* Wiring can only be carried out for controllers with communication functions.  
Maximum baud rate: 9600 bps

\* Wiring can only be carried out for controllers with remote input.

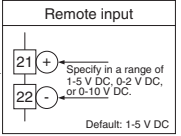

**PV input** \* Not configured at factory before shipment  
See "2. Initial Settings," for more information.

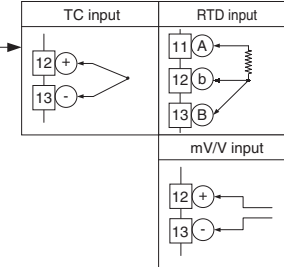

■ Receiving 4-20 mA DC Current Signals with the Controller

\* When receiving 4-20 mA DC current signals, set the PV input type to 1-5 V DC (setpoint "41").

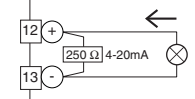

Note: Connecting a 250 Ω resistor to the terminals is optional.  
Model: X010-250-2 (resistor with M3.5 crimp-on terminal lugs)

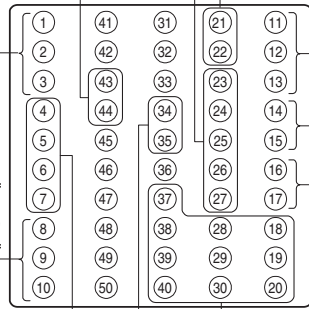

### Control output

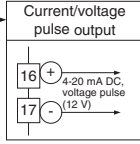

Note: Select this option from the OT parameter.

### Retransmission output

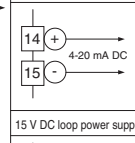

\* PV retransmission is configured at factory before shipment.

Load resistance: 600 Ω or less

\* If 15 V DC loop power supply is used, retransmission output cannot be used.

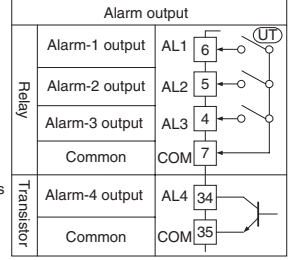

\* Alarm-4 output is optional function

Relay contact rating: 240 V AC, 1 A  
30 V DC, 1 A (resistance load)  
Transistor contact rating: 24 V DC, 50 mA

\* OT is a setup parameter.  
You can change the settings of the parameter OT to change the control output type.  
See "2. Initial Settings," for more information.

\* DIS is a setup parameter.  
Changing DIS setpoint allows you to change the function of external contact input.

Correspondence between DIS parameters and external contact input functions					
When DIS=0	When DIS=1 (Factory-set default)	When DIS=2	When DIS=3	When DIS=4	UT Contact
No function	AUTO when DI1=ON MAN when DI1=OFF	AUTO when DI1=ON MAN when DI1=OFF	STOP when DI1=ON RUN when DI1=OFF	When switching target SP 1 to 4: 1.SP2 SP3 SP4 SP DI1 OFF ON OFF ON DI2 OFF OFF ON ON	DI1 19
No function	STOP when DI2=ON RUN when DI2=OFF	2.SP when DI2=ON 1.SP when DI2=OFF	2.SP when DI2=ON 1.SP when DI2=OFF	DI3 OFF ON OFF ON DI4 OFF ON ON OFF	DI2 18
No function	When switching target SP 1 to 8: 1.SP2 SP3 SP4 SP5 SP6 SP7 SP8 SP DI3 ON OFF ON OFF ON OFF ON OFF DI4 OFF ON ON OFF ON ON OFF	STOP when DI3=ON RUN when DI3=OFF	AUTO when DI3=ON MAN when DI3=OFF	STOP when DI3=ON RUN when DI3=OFF	DI3 40
No function	DI5 OFF OFF ON ON ON ON ON OFF DI6 OFF OFF OFF OFF OFF OFF ON	No function	No function	AUTO when DI4=ON MAN when DI4=OFF	DI4 39
No function	* If all of the contact inputs are set to OFF, the controller uses the immediately preceding target setpoint.	No function	No function	No function	DI5 38
No function	Common	Common	Common	Common	DI6 37
Remote when R/L=ON Local when R/L=OFF	Remote when R/L=ON Local when R/L=OFF	Remote when R/L=ON Local when R/L=OFF	Remote when R/L=ON Local when R/L=OFF	Remote when R/L=ON Local when R/L=OFF	COM 20
Common	Common	Common	Common	Common	R/L 28
					COM 30

Contact rating: 12 V DC, 10 mA or more

Note: External Contact Input  
If the power is turned on when the external contact input is OFF, the mode (SPN, R/L, or A/M) existing before the power is turned off will be continued. (except for RUN/STOP)

Correspondence between parameter OT and control output types			
OT=0 (factory-set default)	OT=1	OT=2	OT=3
Time proportional control Relay output (terminals ①, ② and ③)	Time proportional control Voltage pulse output (terminals ⑥ and ⑦)	Current output (terminals ⑥ and ⑦)	On-off control Relay output (terminals ①, ② and ③)

# UT450 Heating/Cooling Type (Model UT450-2□)

Note: Select this option from the OT parameter.

**Cooling-side control output**

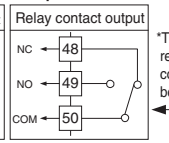
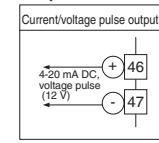

Time proportional PID relay contact output is configured at factory before shipment.

Contact rating: 250 V AC, 3 A  
30 V DC, 3 A (resistance load)

**Heating-side control output**

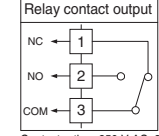

Note: Select this option from the OT parameter.

Time proportional PID relay contact output is configured at factory before shipment.

Contact rating: 250 V AC, 3 A  
30 V DC, 3 A (resistance load)

**Power supply**

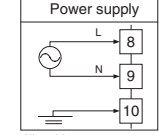

**CAUTION**  
Before carrying out wiring, turn off the power to the controller and check that cables to be connected are not alive with a tester or the like because there is a possibility of electric shock.

Allowable range: 100 to 240 V AC (±10%)  
(free voltage)  
50/60 Hz shared

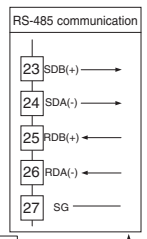

\* Wiring can only be carried out for controllers with communication functions.  
Maximum baud rate: 9600 bps

\* Wiring can only be carried out for controllers with remote input functions.

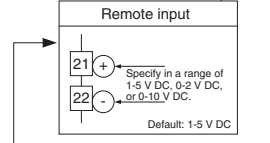

Specify in a range of 1-5 V DC, 0-2 V DC, or 0-10 V DC.  
Default: 1-5 V DC

**PV input** \* Not configured at factory before shipment  
See "2. Initial Settings," for more information.

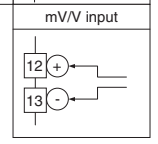
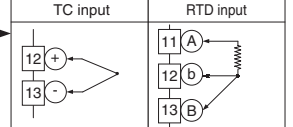

mV/V input

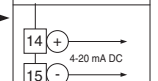

4-20 mA DC

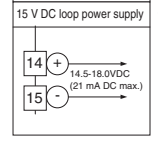

4.5-18.0VDC (21 mA DC max.)

■ Receiving 4-20 mA DC Current Signals with the Controller

\* When receiving 4-20 mA DC current signals, set the PV input type to 1-5 V DC (setpoint "41").

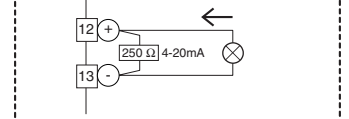

Note: Connecting a 250 Ω resistor to the terminals is optional.  
Model: X010-250-2 (resistor with M3.5 crimp-on terminal lugs)

\* PV retransmission is configured at factory before shipment.

Load resistance: 600 Ω or less

\* If 15 V DC loop power supply is used, retransmission output cannot be used.

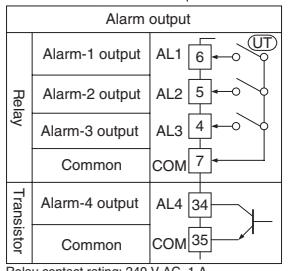

\* Alarm-4 output is optional function

Relay contact rating: 240 V AC, 1 A  
30 V DC, 1 A (resistance load)  
Transistor contact rating: 24 V DC, 50 mA

\* DIS is a setup parameter.  
Changing DIS setpoint allows you to change the function of external contact input.

Correspondence between parameter DIS and external contact input functions					
When DIS=0	When DIS=1 (Factory-set default)	When DIS=2	When DIS=3	When DIS=4	UT
No function	AUTO when DI1=ON MAN when DI1=OFF	AUTO when DI1=ON MAN when DI1=OFF	STOP when DI1=ON RUN when DI1=OFF	When switching target SP 1 to 8: DI1 OFF ON OFF ON DI2 OFF ON OFF ON DI3 OFF ON OFF ON DI4 OFF ON OFF ON	
No function	STOP when DI2=ON RUN when DI2=OFF	2.SP when DI2=ON 1.SP when DI2=OFF	2.SP when DI2=ON 1.SP when DI2=OFF	STOP when DI3=ON RUN when DI3=OFF	
No function	When switching target SP 1 to 8: DI3 ON OFF ON OFF ON OFF ON OFF DI4 OFF ON ON OFF OFF ON ON OFF DI5 OFF OFF OFF ON ON ON OFF DI6 OFF OFF OFF OFF OFF OFF ON	STOP when DI3=ON RUN when DI3=OFF	AUTO when DI3=ON MAN when DI3=OFF	STOP when DI3=ON RUN when DI3=OFF	
No function	No function	No function	No function	AUTO when DI4=ON MAN when DI4=OFF	
No function	No function	No function	No function	No function	
No function	* If all of the contact inputs are set to OFF, the controller uses the immediately preceding target setpoint.	No function	No function	No function	
No function	Common	Common	Common	Common	
Remote when R/L=ON Local when R/L=OFF	Remote when R/L=ON Local when R/L=OFF	Remote when R/L=ON Local when R/L=OFF	Remote when R/L=ON Local when R/L=OFF	Remote when R/L=ON Local when R/L=OFF	
Common	Common	Common	Common	Common	

Note: External Contact Input  
If the power is turned on when the external contact input is OFF, the mode (SPN, R/L, or A/M) existing before the power is turned off will be continued. (except for RUN/STOP)

\* OT is a setup parameter.  
You can change the settings of the parameter OT to change the control output type.  
See "2. Initial Settings," for more information.

Correspondence between parameter OT and heating-side/cooling-side output types								
OT=4 (factory-set default)	OT=5	OT=6	OT=7	OT=8	OT=9	OT=10	OT=11	OT=12
Heating side: Relay output (terminals ①, ② and ③) Cooling side: Relay output (terminals ④, ⑤ and ⑥)	Heating side: Voltage pulse output (terminals ⑬ and ⑭) Cooling side: Relay output (terminals ⑮ and ⑯)	Heating side: Current output (terminals ⑰ and ⑱) Cooling side: Voltage pulse output (terminals ⑲ and ⑳)	Heating side: Relay output (terminals ①, ② and ③) Cooling side: Voltage pulse output (terminals ⑬ and ⑭)	Heating side: Voltage pulse output (terminals ⑬ and ⑭) Cooling side: Voltage pulse output (terminals ⑮ and ⑯)	Heating side: Current output (terminals ⑰ and ⑱) Cooling side: Voltage pulse output (terminals ⑲ and ⑳)	Heating side: Relay output (terminals ①, ② and ③) Cooling side: Current output (terminals ⑰ and ⑱)	Heating side: Voltage pulse output (terminals ⑬ and ⑭) Cooling side: Current output (terminals ⑰ and ⑱)	Heating side: Current output (terminals ⑰ and ⑱) Cooling side: Current output (terminals ⑰ and ⑱)

The control output types, "relay output" and "voltage pulse output" shown in the table above refer to those of time proportional control.  
To change the type to a relay output for on-off control, select "Relay Terminals" and change the setpoint of the proportional band to "0."



# ■ UT450 Position Proportional Type (Model UT450-1□ or UT450-4□)

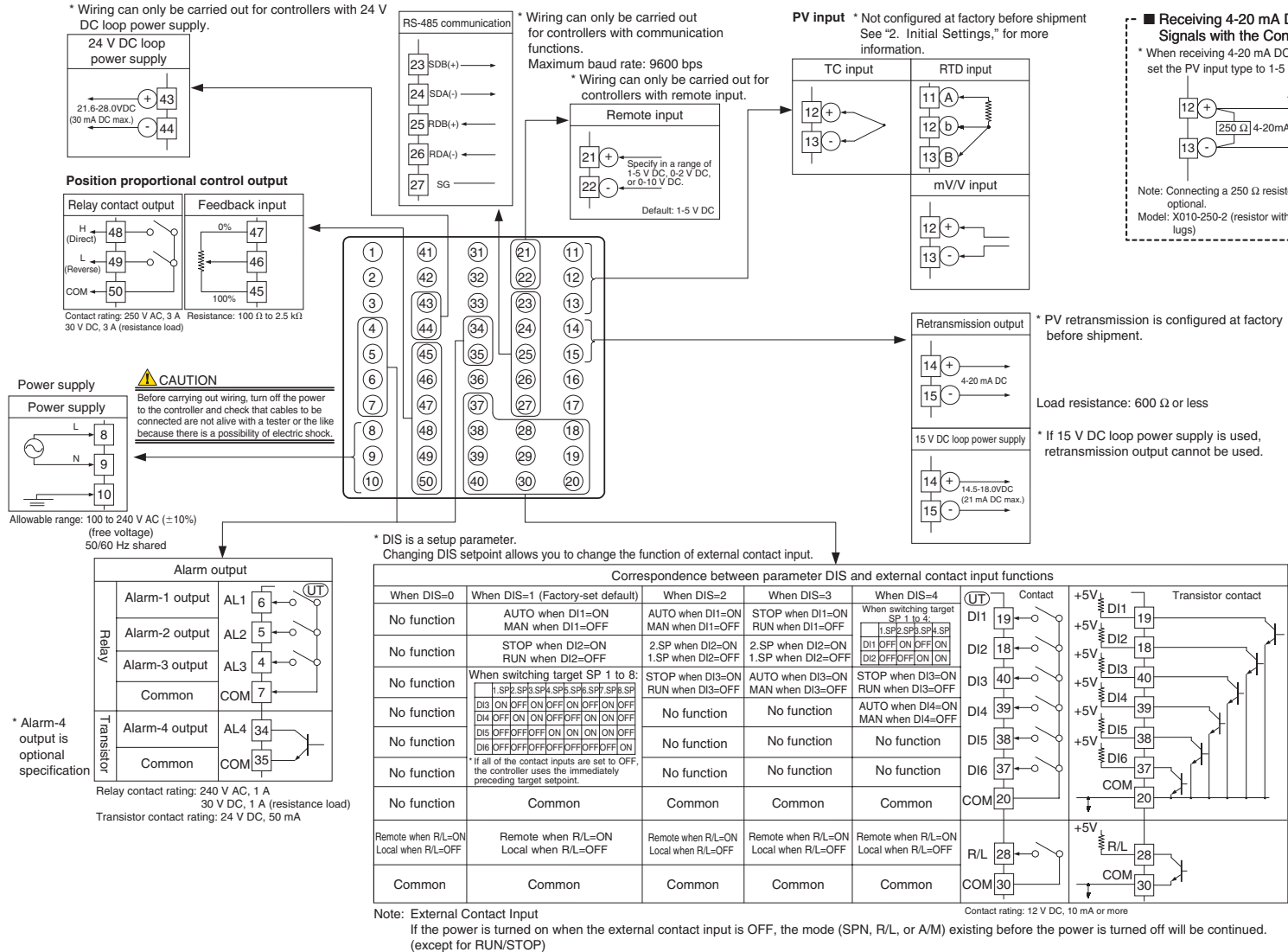

# ■ UT420 Standard Type (Model UT420-0□)

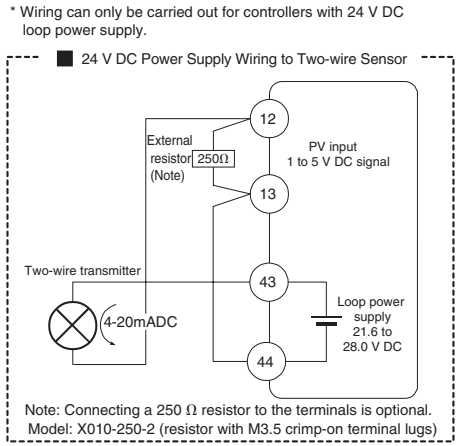
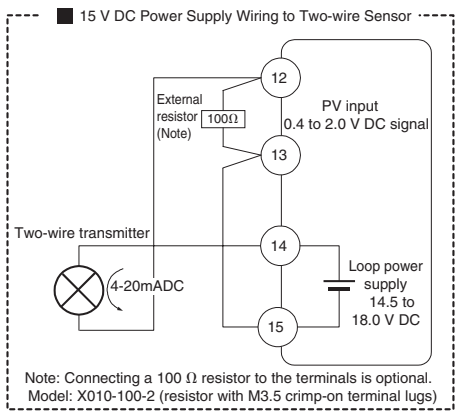
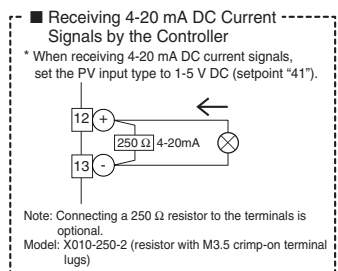
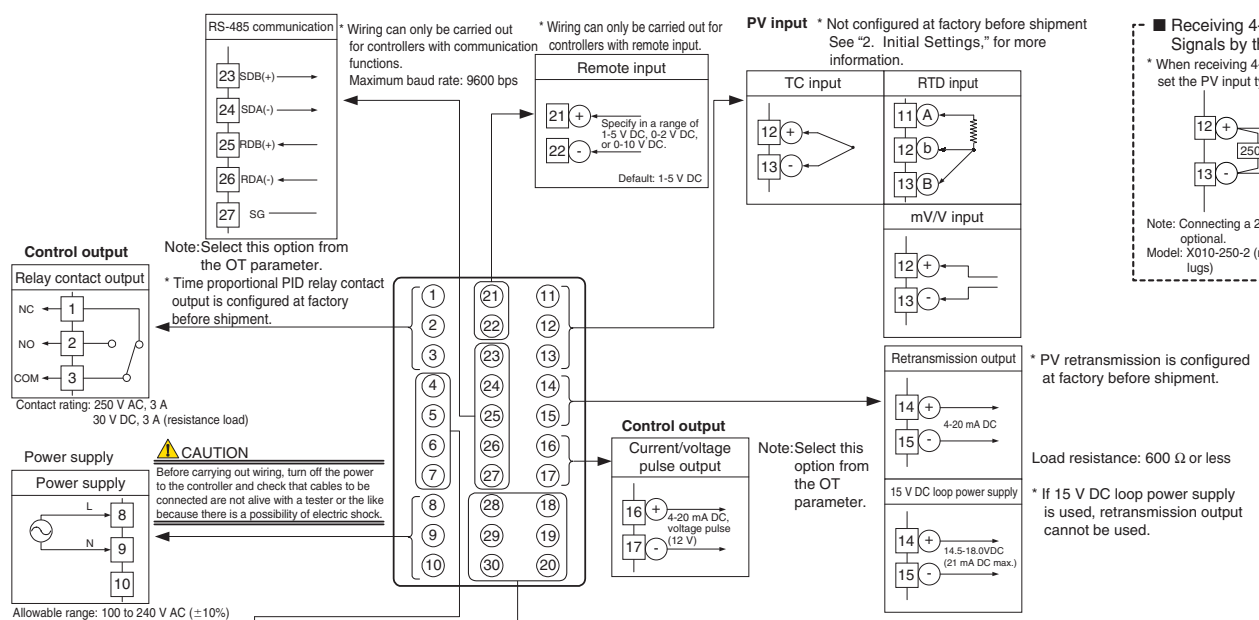

\* DIS is a setup parameter. Changing DIS setpoint allows you to change the function of external contact input.

When DIS=0	When DIS=1 (Factory-set default)	When DIS=2	When DIS=3	When DIS=4	(UT) Contact	+5V Transistor contact
No function	AUTO when DI1=ON MAN when DI1=OFF	AUTO when DI1=ON MAN when DI1=OFF	STOP when DI1=ON RUN when DI1=OFF	When switching target SP 1 to 4: DI1: SP1 SP2 SP3 SP4 DI2: OFF ON OFF ON DI3: OFF OFF ON ON	DI1 19 DI2 18 COM 20	DI1 19 DI2 18 COM 20
No function	STOP when DI2=ON RUN when DI2=OFF	2.SP when DI2=ON 1.SP when DI2=OFF	2.SP when DI2=ON 1.SP when DI2=OFF	Common	DI3 29 R/L 28 COM 30	DI3 29 R/L 28 COM 30
No function	Common	Common	Common	Common		
No function	No function	STOP when DI3=ON RUN when DI3=OFF	AUTO when DI3=ON MAN when DI3=OFF	STOP when DI3=ON RUN when DI3=OFF		
Remote when R/L=ON Local when R/L=OFF	Remote when R/L=ON Local when R/L=OFF	Remote when R/L=ON Local when R/L=OFF	Remote when R/L=ON Local when R/L=OFF	Remote when R/L=ON Local when R/L=OFF		
Common	Common	Common	Common	Common		

Contact rating: 12 V DC, 10 mA or more

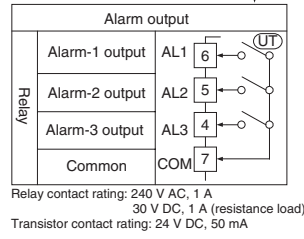

\* OT is a setup parameter.  
 You can change the settings of the parameter OT to change the control output type.  
 See "2. Initial Settings," for more information.

Correspondence between parameter OT and control output types

OT=0 (factory-set default)	OT=1	OT=2	OT=3
Time proportional control Relay output (terminals ①, ② and ③)	Time proportional control Voltage pulse output (terminals ⑥ and ⑦)	Current output (terminals ⑥ and ⑦)	On-off control Relay output (terminals ①, ② and ③)

# 2. Initial Settings

This chapter describes examples of setting PV input types, control output types, and alarm types. Carrying out settings described herein allows you to perform basic control. Refer to examples of various settings to understand how to set parameters required. Refer to “5.1 Parameter Map” for an easy to understand explanation of setting various parameters. If you cannot remember how to carry out an operation during setting, press the  key for more than 3 seconds. This brings you to the display (operating display) that appears at power-on.

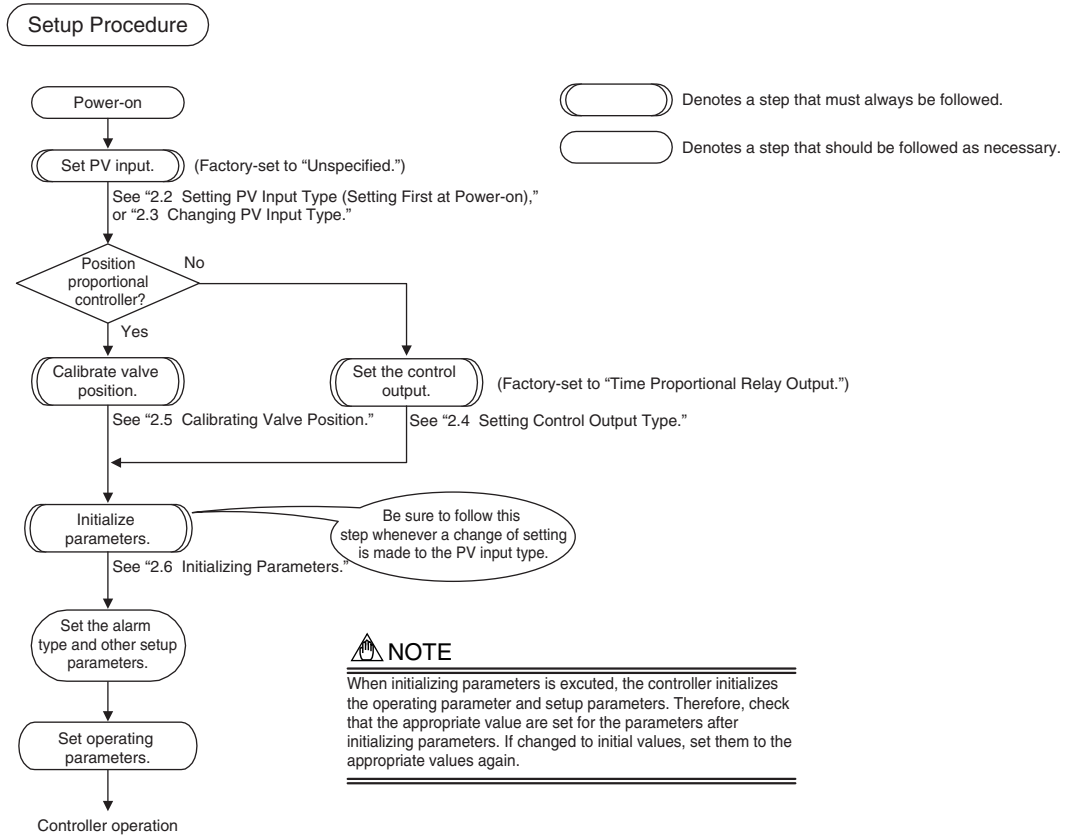

The following explanation of operation for the UT450’s panel, shown in the figure, is the same as that of the UT420’s panel.

# 2.1 Names and Functions of Front Panel Parts

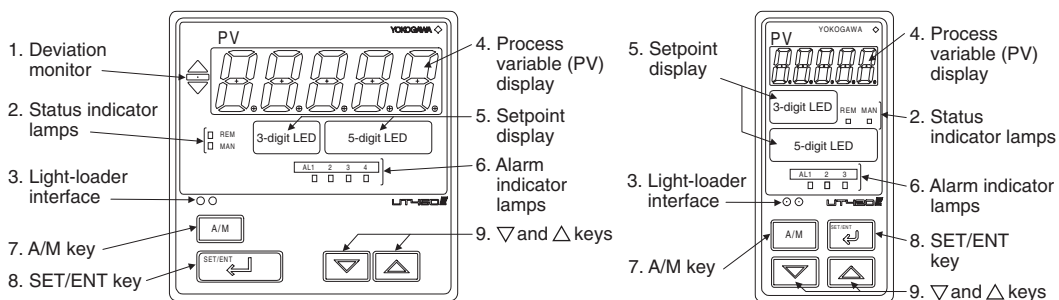



Name of Part	Function
1. Deviation monitor (for UT450 only)	When lit, indicates the status of a deviation (PV - SP). △ : Is lit (in orange) if a deviation exceeds the deviation display range. □ : Is lit (in green) when a deviation is within the deviation display range. ▽ : Is lit (in orange) if a deviation falls below the deviation display range. The deviation monitor goes off if any display other than the operating display or SELECT display is shown.
2. Status indicator lamps	Is lit (in green) to indicate the status of operation or control. REM: Is lit when in remote mode. MAN: Is lit when in manual mode. The lamp blinks when the controller is being auto-tuned.
3. Light-loader interface	Interface for an adapter cable used when setting and storing parameters from a PC. This requires an optional parameter setting tool.
4. Process variable (PV) display	Displays PV. Displays a menu symbol when you set a parameter. Displays an error code (in red) if an error occurs.
5. Setpoint display	Displays a parameter symbol in 3-digit LED. Displays the setpoint of a parameter in 5-digit LED.
6. Alarm indicator lamps	UT450: If any of alarms 1 to 4 occurs, the respective alarm indicator lamp (AL1 to AL4) is lit (in orange). UT420: If any of alarms 1 to 3 occurs, the respective alarm indicator lamp (AL1 to AL3) is lit (in orange).
7. A/M key	Used to switch between the AUTO and MAN modes. Each time you press the key, it switches to the AUTO or MAN mode alternately.
8. SET/ENT key	Used to switch or register a parameter. Pressing the key for more than 3 seconds allows you to switch between the operating display and the main menu for operating parameter setting display alternately.
9. ▽ and △ keys	Used to change numerical values. On setting displays for various parameters, you can change target setpoints, parameters, and output values (in manual operation). Pressing the ▽ key decreases a numerical value, while pressing the △ key causes it to increase. You can hold down a key to gradually increase the speed of change. To change from the parameter setting (operating or setup) display to the menu or from the setup parameter setting display menu to operating parameter setting display menu, press the ▽ and △ keys simultaneously.

## ■ Setting of Main Parameters at the Factory before Shipment

Item	Factory-shipped values for standard type controllers	Factory-shipped values for heating/cooling type controllers	Factory-shipped values for position proportional type controllers
Remote input signal (only for controllers with remote inputs)	1 to 5 V DC (variable)		
Control output	Time proportional PID relay output (variable)	Heating side: Time proportional PID relay output (variable) Cooling side: Time proportional PID relay output (variable)	Relay output (fixed)
Control action	Reverse action (variable)	Not specified	
PID parameter	P = 5.0%, I = 240 seconds, D = 60 seconds.		
Alarm output	Alarm-1: PV high limit, Alarm-2: PV low limit, Alarm-3: PV high limit, Alarm-4: PV low limit		

# 2.2 Setting PV Input Type (Setting First at Power-on)

## NOTE

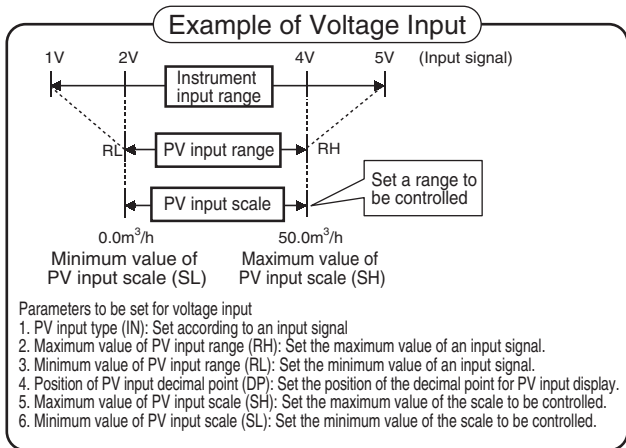
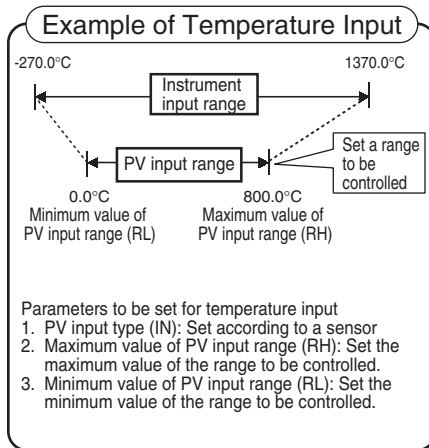

- The controller displays the operating display when the power is turned on. However, if PV input type has not been set, "IN" appears. In this case, first use the  key to display the input range code to use, then press the  key to register it. Then, set the maximum value (RH) and minimum value (RL) of the PV input range (for voltage input, set the maximum value (SH) and minimum value (SL) of the PV input scale). See the operating procedure below for more details.
- The controller is configured to the initial value of each parameter at the factory before shipment. First check the initial values shown in "5.2 Lists of Parameters," and change parameter values as necessary.

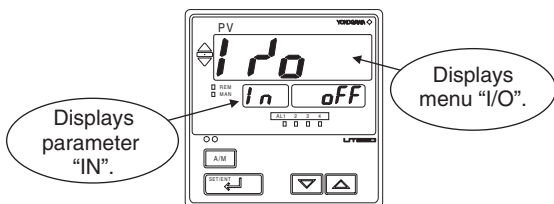

The following operating procedure describes an example of setting a K-type thermocouple (-200.0 to 500.0°C) and a measurement range of 0.0 to 200.0°C.

1. **Display screen at power-on**  
The parameter "IN" for setting the PV input type appears.



2. Press the  or  key to display the required setpoint. The figure below shows an example of setting a K-type thermocouple (-200.0 to 500.0°C). See "Instrument Input Range Codes."

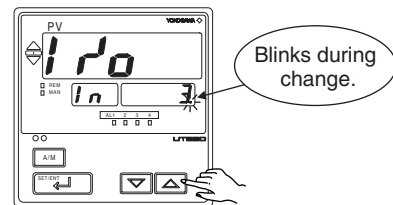

- 3. Press the  key once to register the required setpoint.

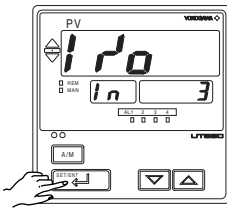

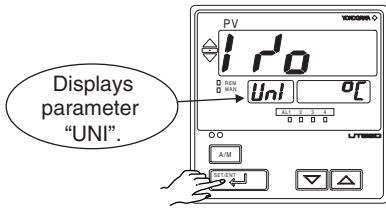

- 4. Press the  key once to display the parameter "UNI" (PV input unit).

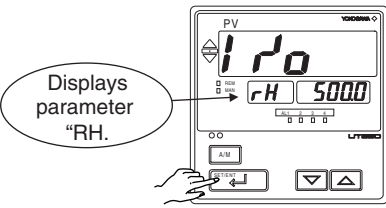

- 5. Press the  key once to display the the parameter "RH" (maximum value of PV input range).



- 6. Press the  or  key to display the required setpoint. The figure below shows an example of setting the maximum value of PV input range to 200.0°C.

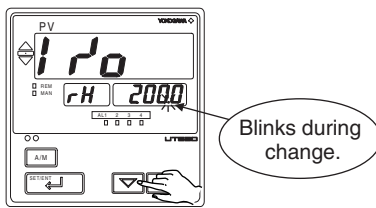

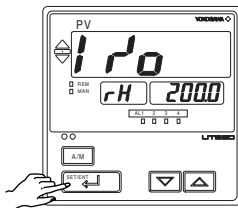

- 7. Press the  key once to register the setpoint.

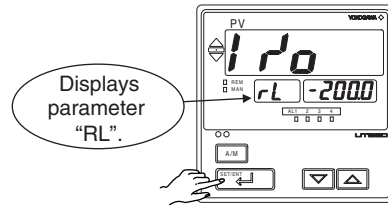

- 8. Press the  key once to display the parameter "RL" (minimum value of PV input range).



- 9. Press the  or  key to display the required setpoint. The figure below shows an example of setting the minimum value of PV input range to 0.0°C.

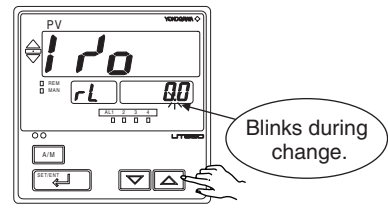

- 10. Press the  key once to register the setpoint.

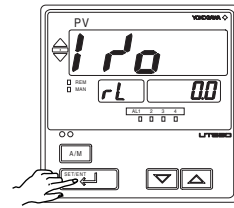

If the type of input is voltage, also configure the PV Input Decimal Point Position (DP), Maximum Value of PV Input Scale (SH) and Minimum Value of PV Input Scale (SL) parameters that follow this step.

- 11. To set the control output type, see step 6. onwards in "2.4 Setting Control Output Type." To finish settings, press the  key for more than 3 seconds. This returns you to the display shown at power-on (figure below).

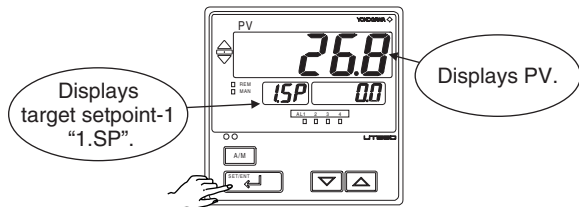

The PV display in the figure above shows the error code for input burnout (*boUt*) if PV input wiring is not yet complete. The error code disappears when you wire the PV input terminals correctly.

## Instrument Input Range Codes

Select the unit from the UNIT parameter.

Input	Type	Instrument Input Range Code	Instrument Input Range	Measurement Accuracy	
Unspecified		OFF	Set the data item PV Input Type "IN" to the OFF option to leave the PV input type undefined.		
Thermocouple	K	1	-270.0 to 1370.0°C -450.0 to 2500.0°F	±0.1% of instrument range ±1 digit at 0°C or more ±0.2% ±1 digit for temperatures below 0°C, where the accuracy is: ±2% of instrument range ±1 digit for temperatures below -200.0°C for a type-K thermocouple, or ±1% of instrument range ±1 digit for temperatures below -200.0°C for a type-T thermocouple.	
		2	-270.0 to 1000.0°C -450.0 to 2300.0°F		
		3	-200.0 to 500.0°C -200.0 to 1000.0°F		
	J	4	-200.0 to 1200.0°C -300.0 to 2300.0°F		
		T	5		-270.0 to 400.0°C -450.0 to 750.0°F
	6		0.0 to 400.0°C -200.0 to 750.0°F		
	B	7	0.0 to 1800.0°C 32 to 3300°F		±0.15% of instrument range ±1 digit at 400°C or more ±5% of instrument range ±1 digit at less than 400°C
	S	8	0.0 to 1700.0°C 32 to 3100°F		±0.15% of instrument range ±1 digit
	R	9	0.0 to 1700.0°C 32 to 3100°F		
	N	10	-200.0 to 1300.0°C -300.0 to 2400.0°F	±0.1% of instrument range ±1 digit ±0.25% of instrument range ±1 digit for temperatures below 0°C	
	E	11	-270.0 to 1000.0°C -450.0 to 1800.0°F	±0.1% of instrument range ±1 digit at 0°C or more ±0.2% ±1 digit for temperatures below 0°C, where the accuracy is: ±1.5% of instrument range ±1 digit for temperatures below -200.0°C for a type-E thermocouple.	
	L(DIN)	12	-200.0 to 900.0°C -300.0 to 1600.0°F		
	U(DIN)	13	-200.0 to 400.0°C -300.0 to 750.0°F		
		14	0.0 to 400.0°C -200.0 to 1000.0°F		
	W	15	0.0 to 2300.0°C 32 to 4200°F	±0.2% of instrument range ±1 digit	
	Platine1 2	16	0.0 to 1390.0°C 32.0 to 2500.0°F	±0.1% of instrument range ±1 digit	
	PR20-40	17	0.0 to 1900.0°C 32 to 3400°F	±0.5% of instrument range ±1 digit at 800°C or more No accuracy is guaranteed at less than 800°C	
	W97Re3- W75Re25	18	0.0 to 2000.0°C 32 to 3600°F	±0.2% of instrument range ±1 digit	
RTD	JPt100	30	-200.0 to 500.0°C -300.0 to 1000.0°F	±0.1% of instrument range ±1 digit (Note 1) (Note 2)	
		31	-150.00 to 150.00°C -200.0 to 300.0°F	±0.2% of instrument range ±1 digit (Note 1)	
	Pt100	35	-200.0 to 850.0°C -300.0 to 1560.0°F	±0.1% of instrument range ±1 digit (Note 1) (Note 2)	
		36	-200.0 to 500.0°C -300.0 to 1000.0°F		
		37	-150.00 to 150.00°C -200.0 to 300.0°F	±0.2% of instrument range ±1 digit (Note 1)	
Standard signal	0.4 to 2 V	40	0.400 to 2.000 V	±0.1% of instrument range ±1 digit Display range is scalable in a range of -19999 to 30000. Display span is 30000 or less.	
	1 to 5 V	41	1.000 to 5.000 V		
DC voltage	0 to 2 V	50	0.000 to 2.000 V		
	0 to 10 V	51	0.00 to 10.00 V		
	-10 to 20 mV	55	-10.00 to 20.00 mV		
	0 to 100 mV	56	0.0 to 100.0 mV		

\* Performance in the standard operating condition (at 23±2°C, 55±10%RH, and 50/60 Hz power frequency)

Note 1: The accuracy is ±0.3°C of instrument range ±1 digit for a temperature range from 0°C to 100°C.

Note 2: The accuracy is ±0.5°C of instrument range ±1 digit for a temperature range from -100°C to 200°C.

\* To receive a 4-20 mA DC signal, select a standard signal of 1 to 5 V DC and connect it to a 250 Ω resistor. This resistor is optional.

Model: X010-250-2 (resistor with M3.5 crimp-on terminal lugs)

 **NOTE**

The controller may automatically initialize the registered operating parameter setpoints if any change is made to the data item PV Input Type (IN), Maximum Value of PV Input Range (RH), Minimum Value of PV Input Range (RL), PV Input Decimal Point Position (DP), Maximum Value of PV Input Scale (SH) or Minimum Value of PV Input Scale (SL). After a change has been made to any of these data items, be sure to verify the registered operating parameter setpoints to ensure that they are correct. If any data item has been changed to its default, set it to a required value.

Ranges Selectable for PV Input

Thermocouple	1 to18
RTD	30, 31, 35 to 37
DC voltage(mV,V)	40, 41, 50, 51, 55, 56

Ranges Selectable for Remote Input

DC voltage(V)	40, 41, 50, 51
---------------	----------------



**How to return to a menu**

**Simultaneously press both the  and  keys once during parameter setting. This lets you return to the parameter menu.**



# 2.3 Changing PV Input Type

The following operating procedure describes an example of changing the setting of K-type thermocouple (-200.0 to 500.0°C) to RTD Pt100 (-200.0 to 500.0°C) and a measurement range of 0.0 to 200.0°C.

PV input terminal	
Thermocouple/mV/V input.....	⑫-⑬
RTD input .....	⑪-⑫-⑬

1. Bring the operating display into view (display appears at power on).

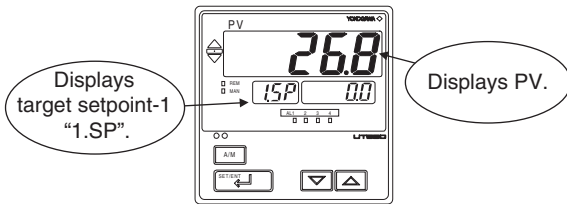

2. Press the key for more than 3 seconds to call up the menu "OP.PA".

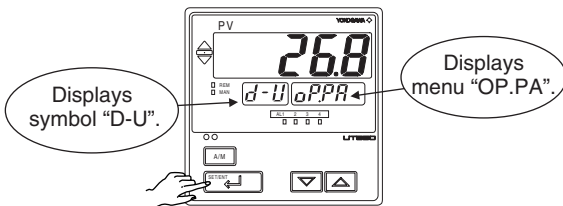

3. Press the key once to display the menu "STUP".

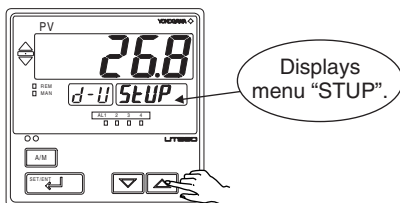

4. Press the key once to display the menu "SP".

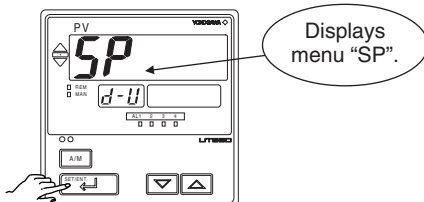

5. Press the key six times to display the menu "I/O".

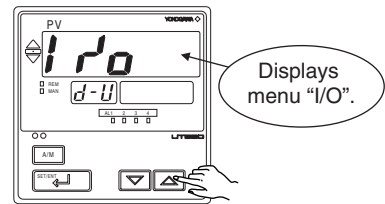

6. Press the key once to display the parameter "IN" (PV input type).

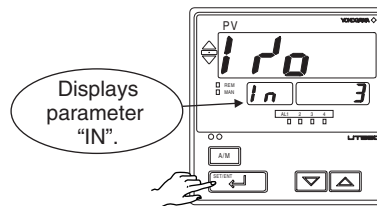

7. Press the or key to display the required setpoint. The figure below shows an example of changing to RTD Pt100 (-200.0 to 500.0°C).

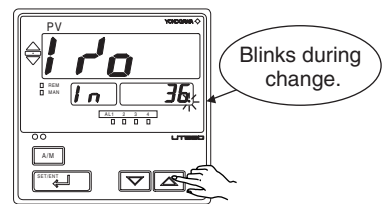

8. Press the key once to register the setpoint.

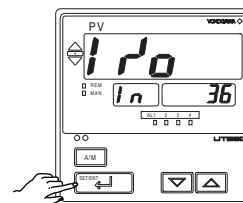

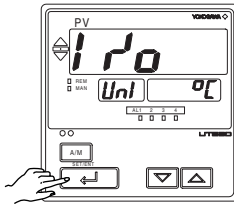

- 9. Press the  key once to display the parameter "UNI".

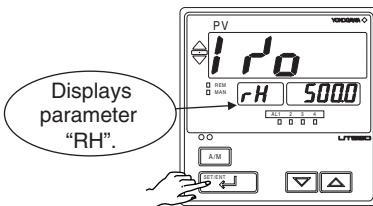

- 10. Press the  key once to display the parameter "RH" (maximum value of PV input range).



- 11. Press the  or  key to display the required setpoint. The figure below shows an example of setting the maximum value of PV input range to 200.0°C.

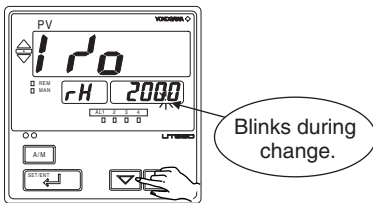

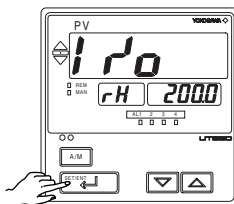

- 12. Press the  key once to register the setpoint.

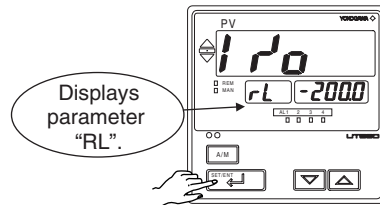

- 13. Press the  key once to display the parameter "RL" (minimum value of PV input range).



- 14. Press the  or  key to display the required setpoint. The figure below shows an example of setting the minimum value of PV input range to 0.0°C.

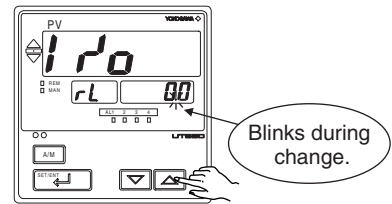

- 15. Press the  key once to register the setpoint.

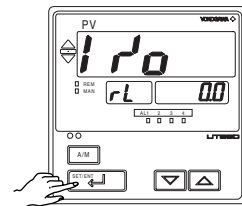

If the type of input is voltage, also configure the PV Input Decimal Point Position (DP), Maximum Value of PV Input Scale (SH) and Minimum Value of PV Input Scale (SL) parameters that follow this step.

- 16. Press the  key for more than 3 seconds. This returns you to the display shown at power-on (figure below).

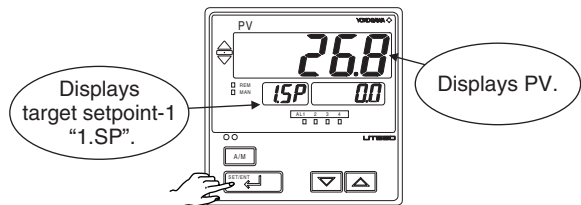

# 2.4 Setting Control Output Type (except for a Position Proportional Controller)

The following operating procedure describes an example of changing time proportional PID relay output (0: factory-shipped value) to current output (2).

Control output terminal	Values in parentheses are setpoints
Time proportional PID relay (0)/on-off(3) output.....	①-②-③
Current (2)/time proportional PID voltage pulse (1) output.....	⑩-⑪

For details on the output terminals for heating/cooling control, see "1.5 Terminal Wiring Diagrams."

1. Bring the operating display into view (display appears at power on).

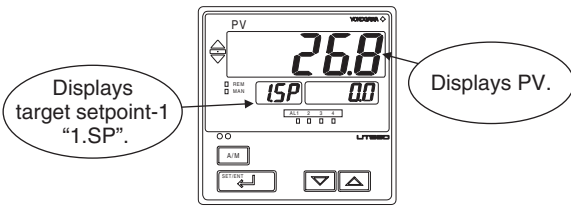

2. Press the **SET/ENT** key for more than 3 seconds to call up the menu "OP.PA".

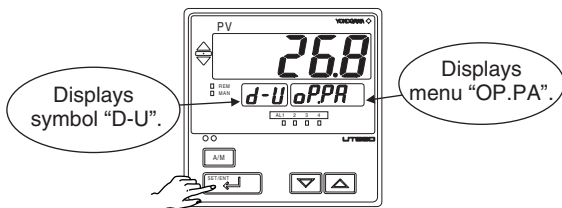

3. Press the **▲** key once to display the menu "STUP".

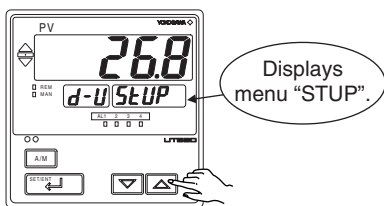

4. Press the **SET/ENT** key once to display the menu "SP".

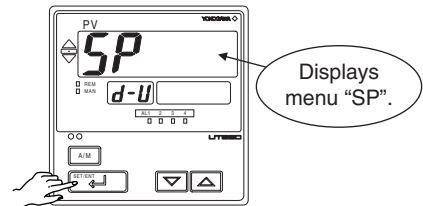

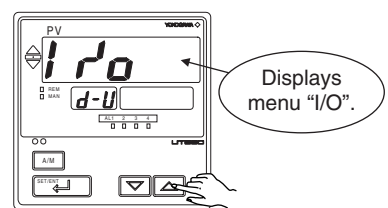

5. Press the **▲** key six times to display the menu "I/O".

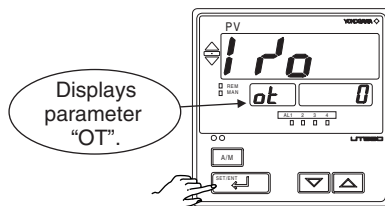

6. Press the **SET/ENT** key several times to display the parameter "OT" (control output type).



7. Press the  or  key to display the required setpoint. The figure below shows an example of setting to current output (4 to 20 mA DC).

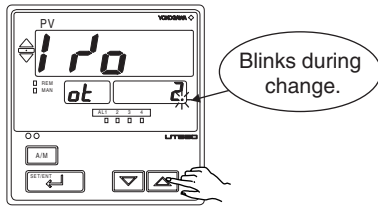

8. Press the  key once to register the setpoint.

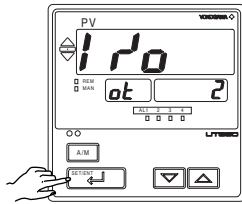

9. Press the  key for more than 3 seconds. This returns you to the display shown at power-on (figure below).

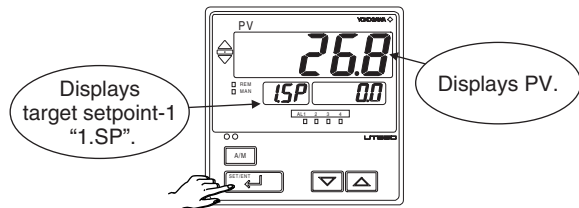

● List of Control Output Types

Parameter Symbol	Name of Parameter	Setting Range	Control Output Types	
<b>ot</b> (OT)	Control output types	0	Time proportional PID relay contact output (terminals ①-②-③)	
		1	Time proportional PID voltage pulse output (terminals ⑩-⑪)	
		2	Current output (terminals ⑩-⑪)	
		3	On/off control relay contact output (terminals ①-②-③)	
		The following 4 to 12 are displayed only for heating/ cooling type controllers.		
		4	Heating-side relay output (terminals ①-②-③), cooling-side relay output (terminals ④⑧-④⑨-④⑩)	
		5	Heating-side pulse output (terminals ⑩-⑪), cooling-side relay output (terminals ④⑧-④⑨-④⑩)	
		6	Heating-side current output (terminals ⑩-⑪), cooling-side relay output (terminals ④⑧-④⑨-④⑩)	
		7	Heating-side relay output (terminals ①-②-③), cooling-side pulse output (terminals ④⑥-④⑦)	
		8	Heating-side pulse output (terminals ⑩-⑪), cooling-side pulse output (terminals ④⑥-④⑦)	
		9	Heating-side current output (terminals ⑩-⑪), cooling-side pulse output (terminals ④⑥-④⑦)	
		10	Heating-side relay output (terminals ①-②-③), cooling-side current output (terminals ④⑥-④⑦)	
11	Heating-side pulse output (terminals ⑩-⑪), cooling-side current output (terminals ④⑥-④⑦)			
12	Heating-side current output (terminals ⑩-⑪), cooling-side current output (terminals ④⑥-④⑦)			

## 2.5 Calibrating Valve Position (for a Position Proportional Controller Only)

The following operation describes a procedure of inputting a feedback signal from a control valve to calibrate the full closed and full open positions of the valve automatically. To calibrate the valve position, you need to carry out wire connections and bring the controller into manual mode. For connections, see “1.5 Terminal Wiring Diagrams” and for entering the manual mode, see “3.8 Switching between AUTO and MAN.”

1. Bring the operating display into view (display appears at power on).

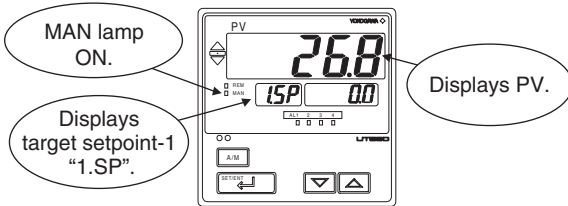

2. Press the **SET/ENT** key for **more than 3 seconds** to call up the menu “OP.PA”.

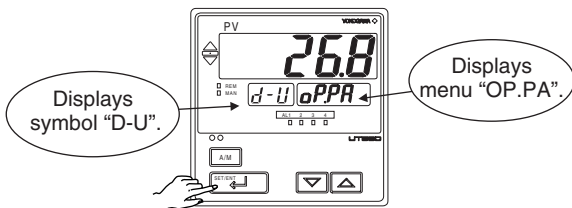

3. Press the **▲** key once to display the menu “STUP”.

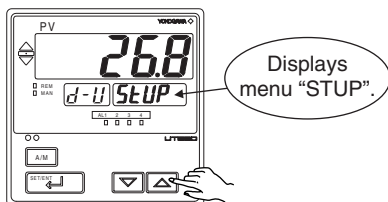

4. Press the **SET/ENT** key once to display the menu “SP”.

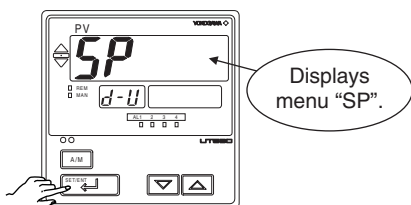

5. Press the **▼** key twice to display menu “VALV”.

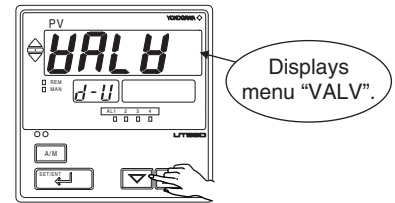

6. Press the **SET/ENT** key once to display the parameter “V.AT”.

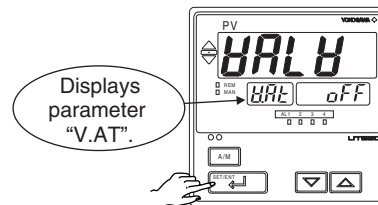

7. Press the **▲** key once to display “ON”.

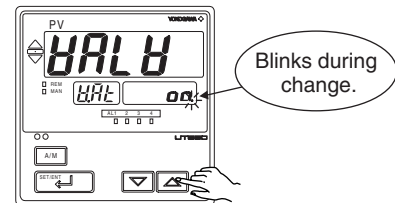

8. Press the **SET/ENT** key once. The controller automatically calibrates the valve position (fully open or closed).

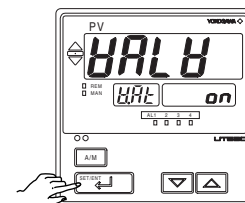

- 9. The controller is viewed as shown below when the valve position is being automatically calibrated.

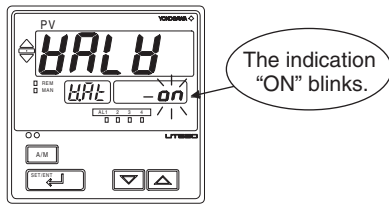

- 10. Calibration is complete when the indication changes from "ON" to "OFF".

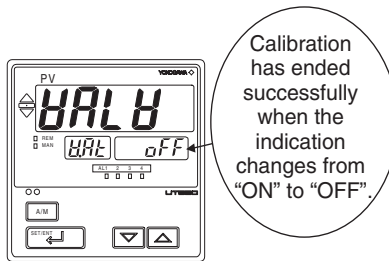

If the controller shows "ERR", check the feedback input wiring and carry out calibration again.

- 11. Press the  key for more than 3 seconds. This returns you to the display shown at power on (figure below).

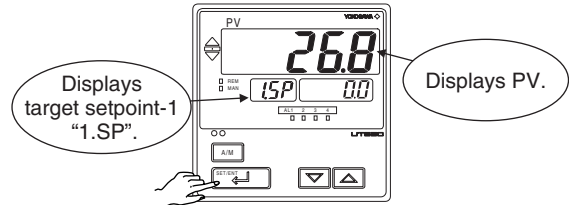

## 2.6 Initializing Parameters

Be sure to follow the steps below after a change of setting has been made to the data item PV Input Type, PV Input Range or PV Input Scale.

### NOTE

When initializing parameter is executed, the controller initializes the operating parameters and setup parameters. Therefore, check that the appropriate values are set for the parameters after initializing parameters. If changed to initial values, set them to the appropriate values again.

- 1. Bring the operating display into view (appears at power-on).

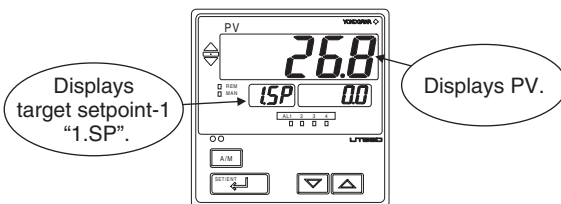

- 2. Press the  key for more than 3 seconds to call up the menu "OP.PA".

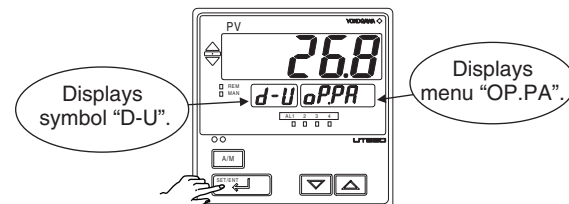

- 3. Press the  key once to display the menu "STUP".

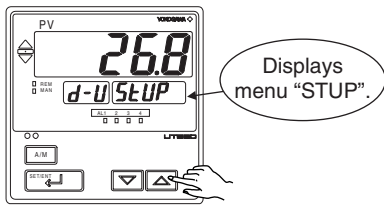

- 4. Press the  key once to display the menu "SP".

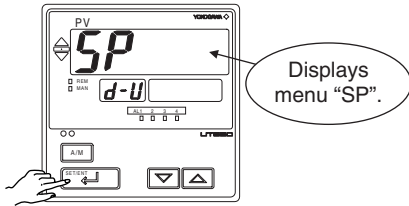

- 5. Press the  key once to display the menu "INIT".

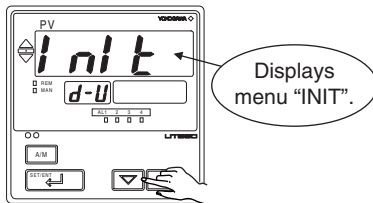

- 6. Press the  key once to display the parameter "INI".

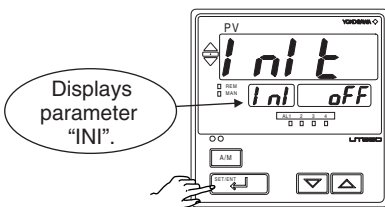

- 7. Press the  key to display "ON".

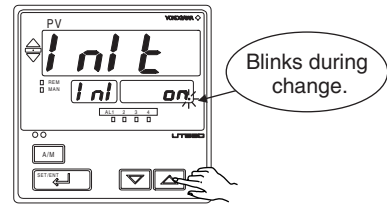

- 8. Press the  key once. The display momentarily becomes blank (which is normal), indicating the parameters have been initialized.

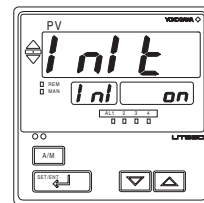

- 9. Press the  key for more than 3 seconds. This returns you to the display shown at power-on (figure below).

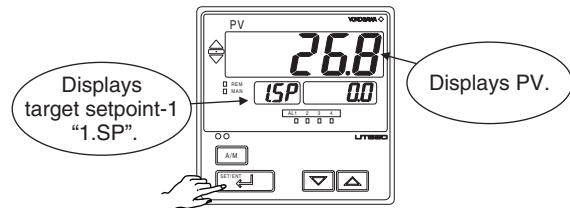

## 2.7 Changing Alarm Type

The following operating procedure describes an example of changing alarm-1 (factory-shipped setting: PV high limit alarm) to PV low limit alarm.

When you have changed alarm type, the alarm setpoint will be initialized; set the alarm setpoint again.

Alarm output terminals	Factory-shipped settings
Alarm-1 (terminal numbers ⑥-⑦)	.....PV high limit alarm
Alarm-2 (terminal numbers ⑤-⑦)	.....PV low limit alarm
Alarm-3 (terminal numbers ④-⑦)	.....PV high limit alarm
Alarm-4 (terminal numbers ⑳-㉑)	.....PV low limit alarm

1. Bring the operating display into view (display appears at power on).

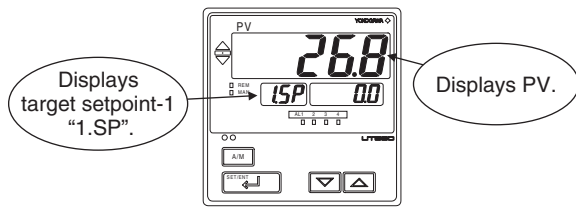

2. Press the **SETTING** key for more than 3 seconds to call up the menu "OP.PA".

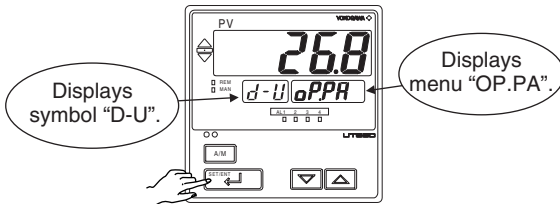

3. Press the **UP** key once to display the menu "STUP".

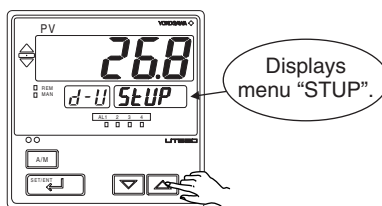

4. Press the **SETTING** key once to display the menu "SP".

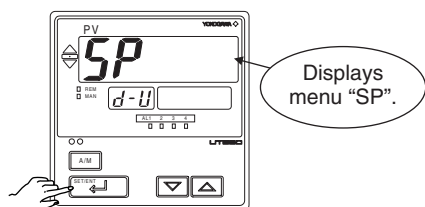

5. Press the **UP** key once to display the menu "ALM".

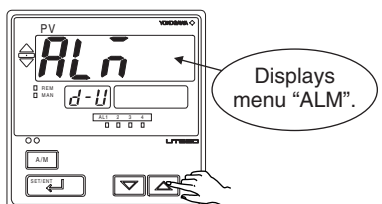

6. Press the **SETTING** key once to display the parameter "AL1" (alarm-1 type).

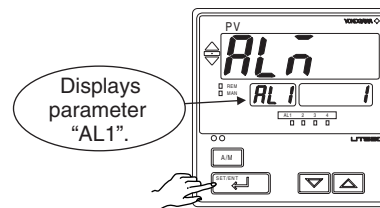

7. Press the **UP** or **DOWN** key to display the required setpoint. The figure below shows an example of setting PV low limit alarm.

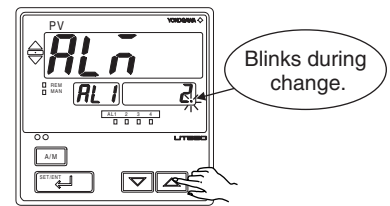

8. Press the **SETTING** key once to register the setpoint.

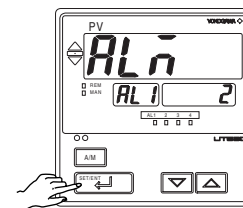

You can take the same steps for alarm-2 type (AL2), alarm-3 type (AL3), and alarm-4 type (AL4) that are displayed after this.

9. Press the **SETTING** key for more than 3 seconds. This returns you to the display shown at power-on (figure below).

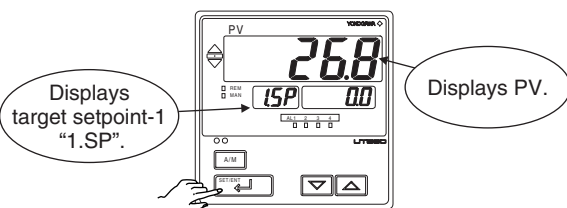

10. See "3.5 Setting Alarm Setpoints" when setting an alarm setpoint.



## List of Alarm Types

The table below shows the alarm types and alarm actions.

In the table, codes 1 to 10 are not provided with stand-by actions, while codes 11 to 20 are provided with stand-by actions.

Alarm type	Alarm action "Open/close" shows status of relay contact, and "lit" and "unlit" shows status of lamp	Alarm type code		Alarm type	Alarm action "Open/close" shows status of relay contact, and "lit" and "unlit" shows status of lamp	Alarm type code	
		Contact closes if alarm occurs	Contact opens if alarm occurs			Contact closes if alarm occurs	Contact opens if alarm occurs
No alarm		OFF					
PV high limit		1		De-energized on deviation low limit alarm			6
		11				16	
PV low limit		2		Deviation high and low limits		7	
		12				17	
Deviation high limit		3		Deviation within high and low limits		8	
		13				18	
Deviation low limit		4		De-energized on PV high limit		9	
		14				19	
De-energized on deviation high limit alarm		5		De-energized on PV low limit		10	
		15				20	
Timer function (control stability report event) (for Alarm-1 only)	Upward (hour/minute)	21		Sensor grounding alarm	Sensor grounding alarm	25	
	Downward (hour/minute)	22		Fault diagnosis output (Note 1)	Fault diagnosis output (Note 1)	26	
	Upward (minute/second)	23		FAIL output (Note 2)	The controller stops when in a FAIL state (Note 2). The control output is set to "OFF" or "0%" and the alarm output is set to "OFF".	27	
	Downward (minute/second)	24					
SP high limit		28		Output high limit		30	
		29				31	
SP low limit				Output low limit			

Note 1: The fault diagnosis output turns on if there is an input burnout, A/D converter failure, or reference junction compensation (RJC) failure. For input burnout or A/D converter failure, the control output is set to the setpoint of the Preset Output Value operating parameter (PC).

Note 2: The FAIL output is on under normal operation and turns off if there is a failure.

**Stand-by Action**

It is effective in the following cases where;

- the power is turned on
- the target setpoint is changed
- the target setpoint number is switched (however, except for remote setpoint)

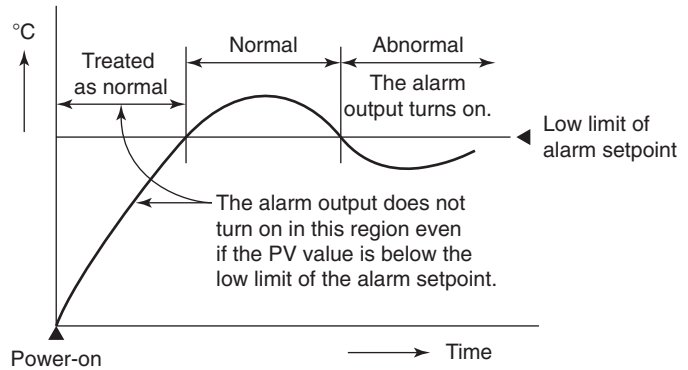

## 2.8 Description of Multiple Setpoints and PID

The UT450/UT420 has a maximum of eight target setpoints, and has PID for each of these setpoints. The following shows the correspondence between the target setpoint numbers (SPN), target setpoints (SP), and PID parameters.

Note: In factory-shipped settings, up to four target setpoints are available. To use five or more target setpoints, use setup parameter “GRP” (PID group number) to set the number of setpoints to use.

For example, if you have set “2” to the target setpoint number (SPN), the control parameters available are target setpoint (2.SP), proportional band (heating-side proportional band) (2.P), integral time (heating-side integral time) (2.I), derivative time (heating-side derivative time) (2.D), cooling-side proportional band (2.Pc), cooling-side integral time (2.Ic), and cooling-side derivative time (2.Dc).

To use multiple target setpoints, see the table below to check the corresponding parameters.

Target setpoint number (SPN)	Target setpoint (SP)	PID parameter					
		Proportional band (heating-side proportional band)	Integral time (heating-side integral time)	Derivative time (heating-side derivative time)	Cooling-side proportional band	Cooling-side integral time	Cooling-side derivative time
SPN=1	1.SP	1.P	1.I	1.D	1.Pc	1.Ic	1.Dc
SPN=2	2.SP	2.P	2.I	2.D	2.Pc	2.Ic	2.Dc
SPN=3	3.SP	3.P	3.I	3.D	3.Pc	3.Ic	3.Dc
SPN=4	4.SP	4.P	4.I	4.D	4.Pc	4.Ic	4.Dc
SPN=5	5.SP	5.P	5.I	5.D	5.Pc	5.Ic	5.Dc
SPN=6	6.SP	6.P	6.I	6.D	6.Pc	6.Ic	6.Dc
SPN=7	7.SP	7.P	7.I	7.D	7.Pc	7.Ic	7.Dc
SPN=8	8.SP	8.P	8.I	8.D	8.Pc	8.Ic	8.Dc

# 3. Operations

This chapter describes key entries for operating the controller. For operations using external contact inputs, see “1.5 Terminal Wiring Diagrams.” If you cannot remember how to carry out an operation during setting, press the  key for more than 3 seconds. This brings you to the display (operating display) that appears at power-on.

## 3.1 Monitoring-purpose Operating Displays Available during Operation

The monitoring-purpose operating displays available during operation are roughly classified into two groups depending on the types of controller and control output. One group is operating displays for standard and position proportional controllers and the other group is operating displays for a heating/cooling controller.

### ■ Operating Displays for Standard and Position Proportional Controllers

#### ● SP Display

The PV input value appears on the PV display.

The target setpoint (1.SP) appears on the Setpoint display.(can be changed)

#### ● OUT Display

The PV input value appears on the PV display.

The control output value (OUT) appears on the Setpoint display. (can be changed in MAN mode)

When in position proportional control, the Setpoint display shows the valve opening (0% to 100%).

#### ● PID Number Display

The PV input value appears on the PV display.

The PID number (PID) being used appears on the Setpoint display.

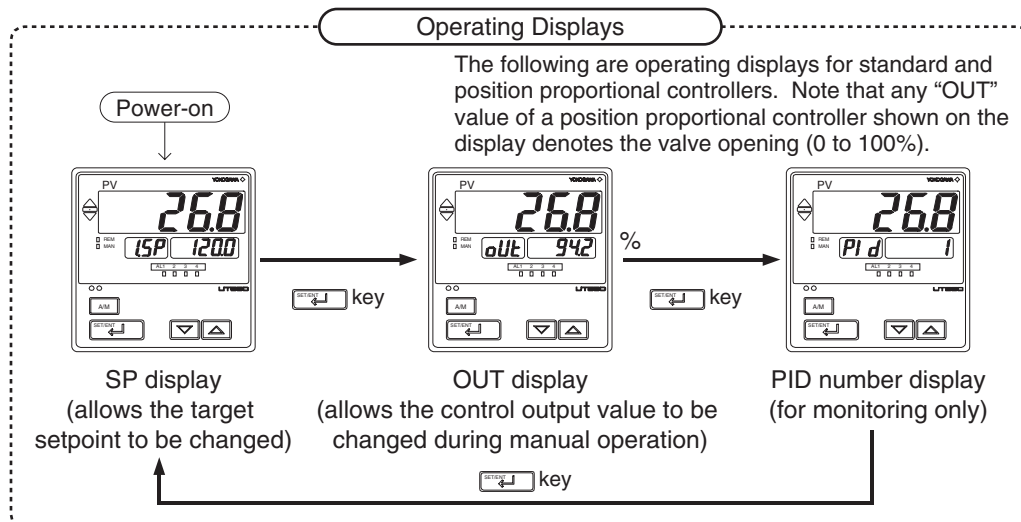

## ■ Operating Displays for a Heating/Cooling Controller

### ● SP Display

The PV input value appears on the PV display.

The target setpoint (1.SP) appears on the Setpoint display. (can be changed)

### ● Heating/Cooling OUT Display

The PV input value appears on the PV display.

The heating and cooling sides control output value (C.H) appears on the Setpoint display. (can be changed in MAN mode)

### ● PID Number Display

The PV input value appears on the PV display.

The PID number (PID) being used appears on the Setpoint display.

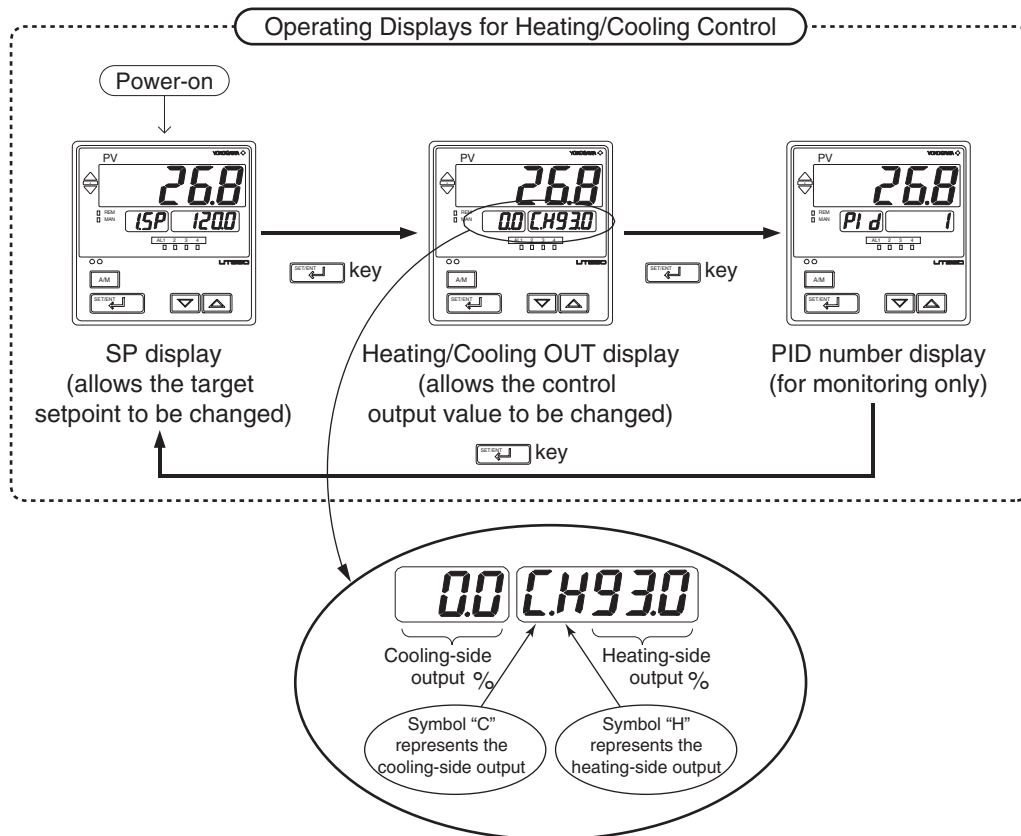

## 3.2 Setting Target Setpoint (SP)

The following operating procedure describes an example of setting 150.0 to a target setpoint. In automatic operation, the controller starts control using set target setpoints.

1. Bring the operating display into view (display appears at power on).

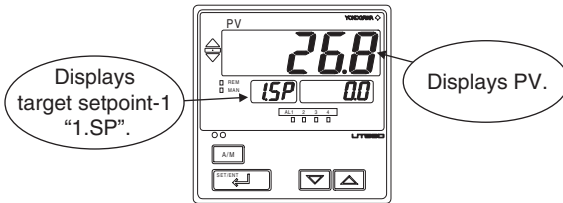

2. Press the  or  key to display the required setpoint.

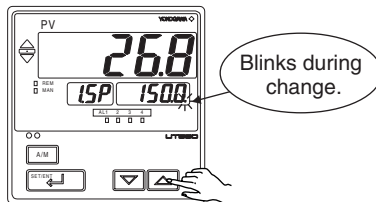

3. Press the  key once to register the setpoint.

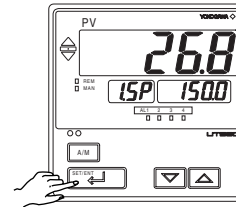

## 3.3 Performing/Canceling Auto-tuning

Auto-tuning should be carried out after setting a target setpoint (SP). Make sure the controller is in automatic operation mode (AUTO) and in running state (RUN) before carrying out auto-tuning. See "3.8 Switching between AUTO and MAN," to change to AUTO and "3.7 Switching between Run and Stop," to change to Run.

### NOTE

When on-off control is being used, auto-tuning cannot be carried out. Moreover, do not perform auto-tuning when controlling any of the following processes.

- Control processes with quick response such as flow control or pressure control
- Processes where even temporary output on/off results in inconvenience
- Processes where a large output change at control element results in inconvenience
- Processes where variations in PV may exceed an allowable range, adversely affecting product quality

1. Bring the operating display into view (display appears at power on).

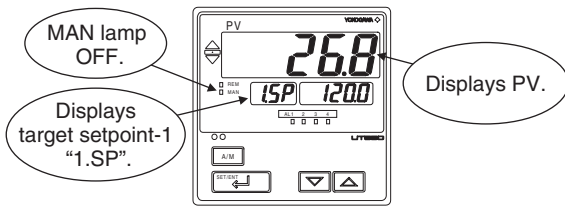

2. Press the  key for more than 3 seconds to call up the menu "OP.PA".

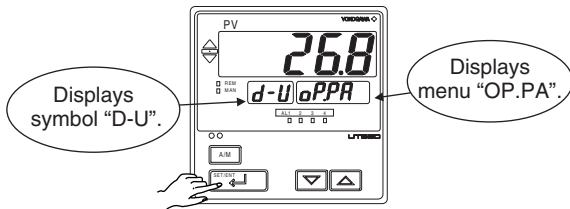

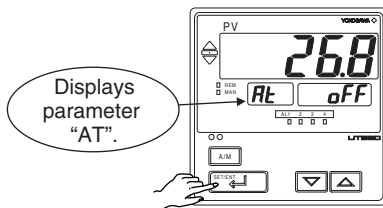

3. Press the  key several times to display the parameter "AT".

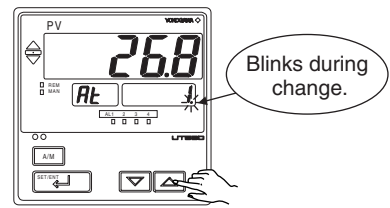

4. Press the  or  key to display the required setpoint. Tuning for 1.SP is AT = 1.



To cancel auto-tuning, set AT = OFF.

5. Press the  key once to register the setpoint. (This starts auto-tuning.) If the  key is pressed when AT = OFF, auto-tuning will be cancelled. In this case, PID contains the value existing before auto-tuning.

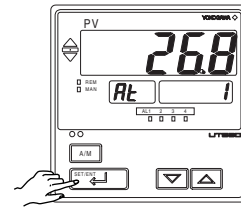

6. During auto-tuning, the panel indications become as shown below.

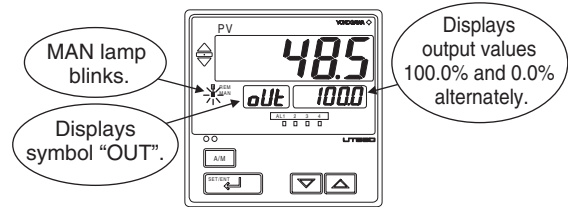

Auto-tuning is complete when the MAN lamp goes off.

# 3.4 Setting PID Manually

If you know the values to be set or if suitable PID constants cannot be obtained by auto-tuning, follow the procedure below to set values.

1. Bring the operating display into view (display appears at power on).

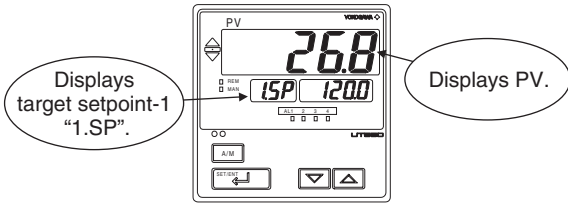

2. Press the key for more than 3 seconds to call up the menu "OP.PA".

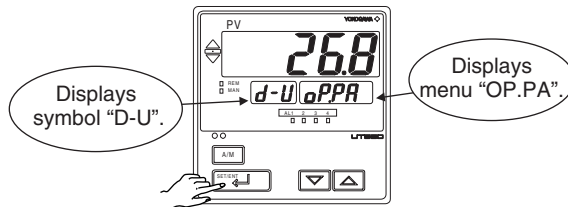

3. Press the key several times to display the parameter "PID".

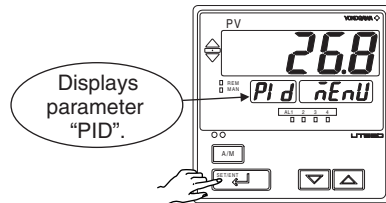

4. Press the key once to display "1Gr.".

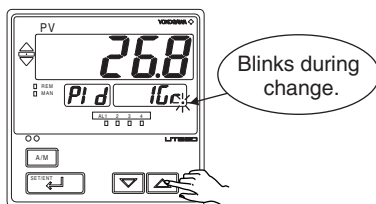

5. Press the key once to register the setpoints.

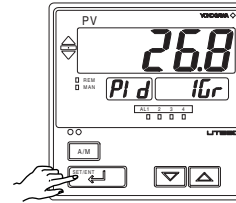

6. Press the key once to display the parameter "1.P" (proportional band for 1.SP).

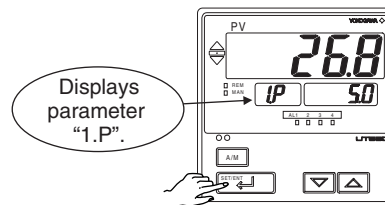

7. Press the or key to display the required setpoint.

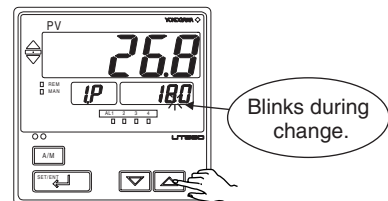

8. Press the key once to register the setpoint.

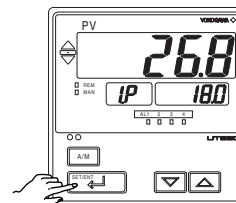

The same steps can be used for integral time (1.I), derivative time (1.D), and proportional band (1.P) that are displayed after this.

[TIP]

The PID parameter numbers set in step 4. should be set as follows:

- In case of PID for 1.SP, PID = 1Gr
- In case of PID for 2.SP, PID = 2Gr
- In case of PID for 3.SP, PID = 3Gr
- In case of PID for 4.SP, PID = 4Gr

Note:

For use of 5.SP or more, set the PID parameter numbers in the same way as those above.

- Press the  key for more than 3 seconds. This returns you to the display shown at power-on (figure below).

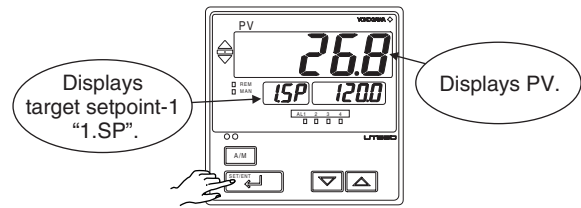

### 3.5 Setting Alarm Setpoints

The following operating procedure describes an example of setting 160.0 to alarm-1 setpoint. Check alarm type before setting the alarm setpoint. To change alarm type, see "2.7 Changing Alarm Type."

Alarm output terminals	Factory-shipped settings
Alarm-1 (terminal numbers ⑥-⑦)	PV high limit alarm
Alarm-2 (terminal numbers ⑤-⑦)	PV low limit alarm
Alarm-3 (terminal numbers ④-⑦)	PV high limit alarm
Alarm-4 (terminal numbers ③-⑤)	PV low limit alarm

- Bring the operating display into view (display appears at power on).

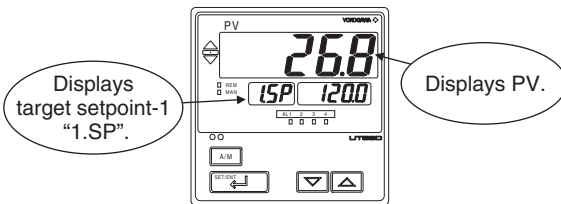

- Press the  key for more than 3 seconds to call up the menu "OP.PA".

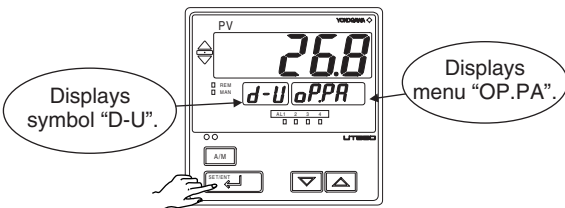

- Press the  key once to display parameter "A1".

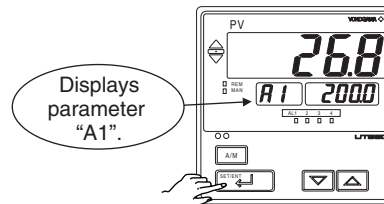

- Press the  or  key to display the required setpoint.

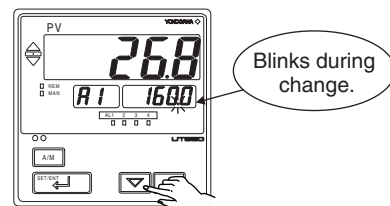



5. Press the  key once to register the setpoint.

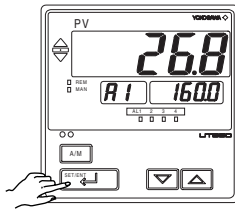

You can take the same steps for alarm-2 setpoint (A2), alarm-3 setpoint (A3), and alarm-4 setpoint (A4) that are displayed after this.

6. Press the  key for more than 3 seconds. This returns you to the display shown at power-on (figure below).

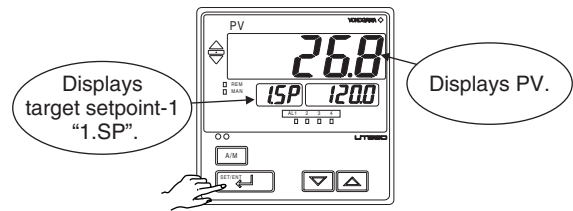

### 3.6 Selecting Target Setpoint Numbers (SPN)

The following operating procedure describes an example of changing a target setpoint number (SPN) from 1 to 2.

 **NOTE**

- If a target setpoint number has been switched using contact input, when the contact input is on, that number cannot be selected by keystroke.
- No target setpoint number can be selected by key operation if the setup parameter DIS (DI function selection) is set to "2" or "3".

1. Bring the operating display into view (display appears at power on).

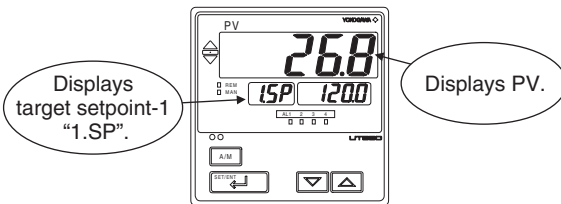

2. Press the  key for more than 3 seconds to call up the menu "OP.PA".

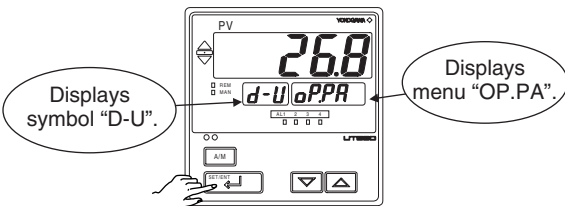

3. Press the  key several times to display the parameter "SPN".

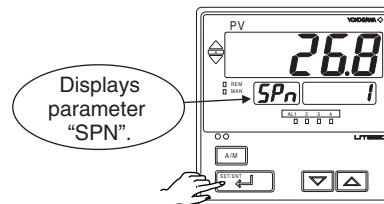

4. Press the  or  key to display the required setpoint.

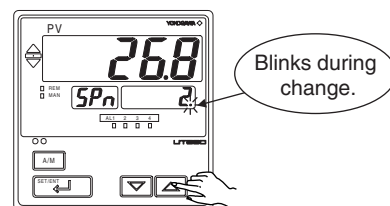

- 5. Press the  key once to register the setpoint.

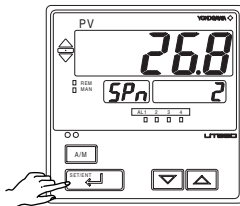

- 6. Press the  key for more than 3 seconds. This returns you to the display shown at power-on (figure below).

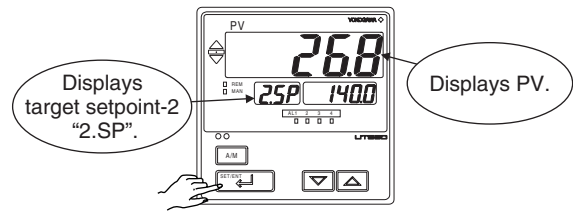

### 3.7 Switching between Run and Stop

The following operation describes the procedure of switching from the run state (RUN) to stop state (STOP).



Factory-shipped setting does not allow switching between RUN and STOP by keystroke. To perform switching by keystroke, configure setup parameter "DIS = 0."

When the controller is stopped, input and outputs are as follows:

PV input	Displays PV.
Control output	Preset output value (factory-shipped setting: 0%)
Alarm output	ON in the event of an alarm

- 1. Bring the operating display into view (display appears at power on).

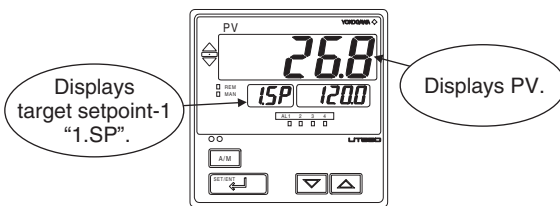

- 2. Press the  key for more than 3 seconds to call up the menu "OP.PA".

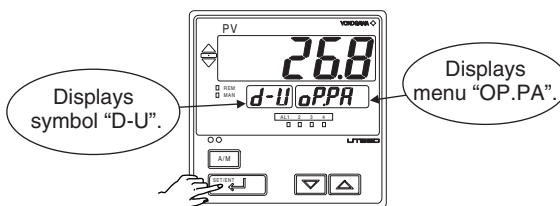

- 3. Press the  key several times to display the parameter "S/R".

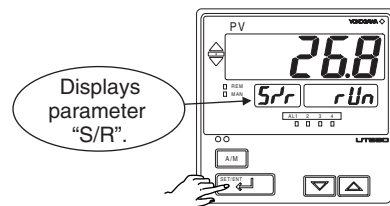

- 4. Press the  key to display "STOP".

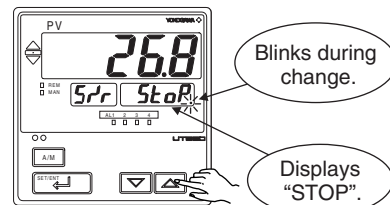

- 5. Press the  key once to register the setpoint.

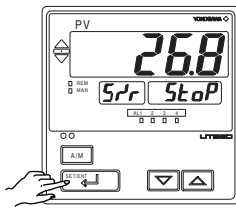

- 6. Press the  key for more than 3 seconds. This returns you to the display shown at power-on (figure below).

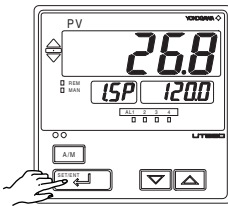

The following display is used to view the output value when the controller is in STOP (OUT display).

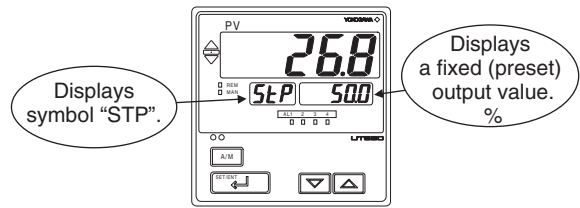

Switching the target setpoint number (SPN) in STOP allows any preset output value (n.PO) to be switched. The "n" is same as the target setpoint number.

■ In heating / cooling control, output display in STOP.

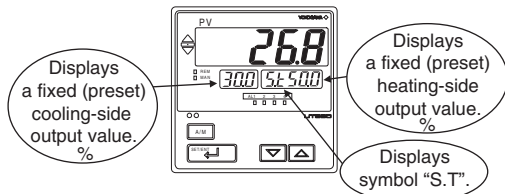

■ In Position proportional control, output display in STOP.

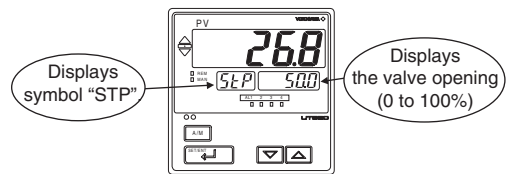

## 3.8 Switching between AUTO and MAN

### NOTE

If AUTO and MAN have been switched using contact input, when the contact input is ON, switching between AUTO and MAN cannot be achieved by keystroke.

- 1. Bring the operating display into view (display appears at power on).

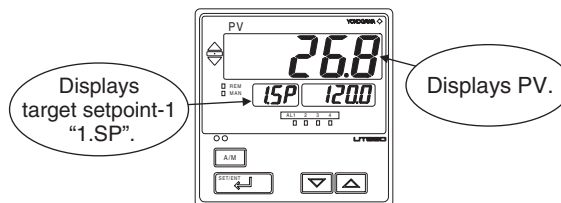

- Each time you press the  key on the front panel of the instrument, AUTO and MAN is switched alternately.

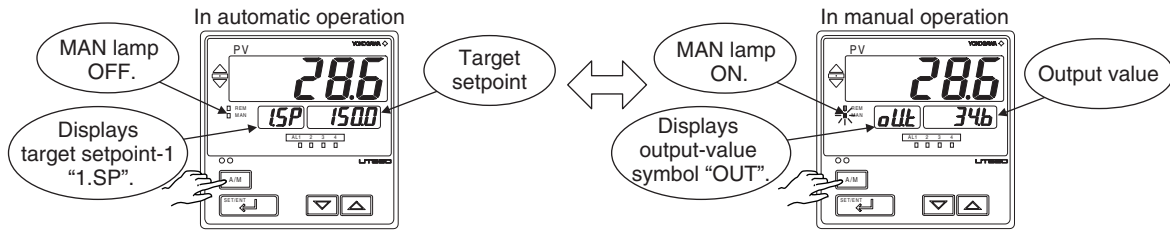



### 3.9 Manipulating Control Output during Manual Operation





**NOTE**

Control output cannot be changed if the controller is stopped. In this case, the preset output value (operating parameter PO) will be output. In heating/cooling control, the heating-side preset output value (operating parameter PO) and cooling-side preset output value (operating parameter Oc) will be output.

A control output value is linked with a display value changed using the  or  key. Note that the control output changes as displayed without requiring the  key.

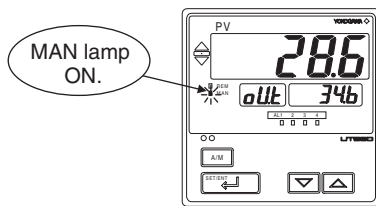
- Bring manual operating display into view. For switching to manual operation, see “3.8 Switching between AUTO and MAN.”



- Press the  or  key to change a control output value. You don't need to press the  key.

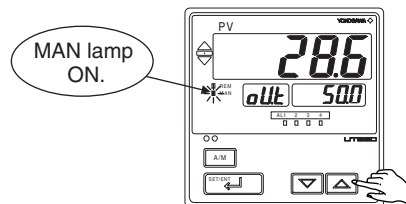

### ■ Manipulating the Control Output during Heating/Cooling Control

Showing the Heating/Cooling OUT display.

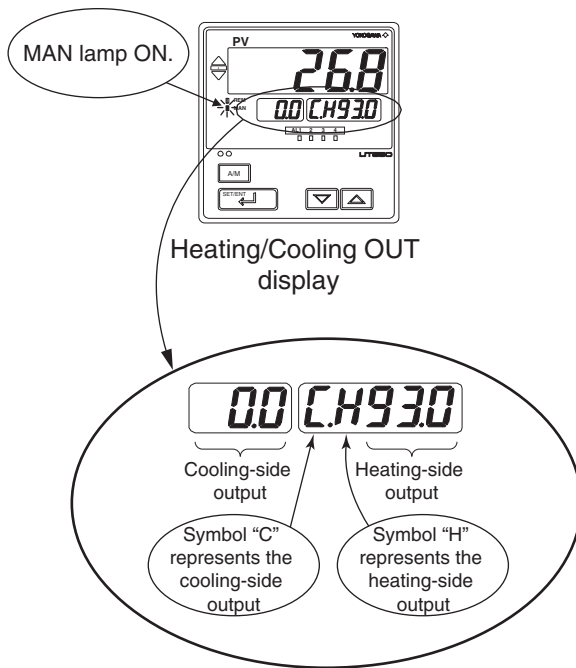

### ● Controller Behavior and Control Output Manipulation when the Dead Band is Positive

The following is an example when the DB parameter is set at 12.4%.

If you hold down the  $\square \nabla$  key with the heating-side output under manipulation (i.e., cooling-side output C = 0.0%), the heating-side output (H =) decreases. Consequently, both the heating-side and cooling-side outputs change to 0.0%. If you keep the  $\square \nabla$  key held down longer, you enter the state of manipulating the cooling-side output, and its value begins to increase.

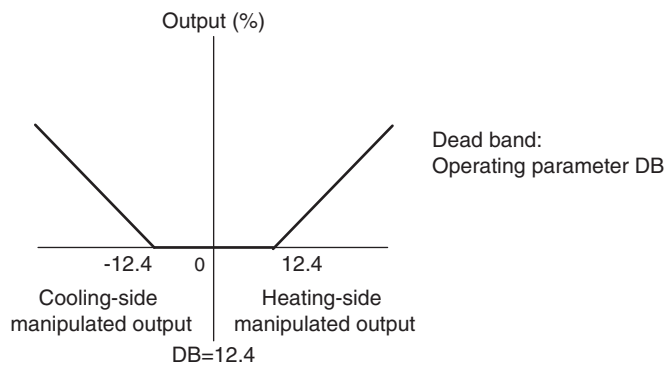

Inversely, if you hold down the  $\square \triangle$  key with the cooling-side output under manipulation (i.e., heating-side output H = 0.0%), the cooling-side output (C =) decreases. Consequently, both the heating-side and cooling-side outputs go to 0.0%. If you keep the  $\square \triangle$  key held down longer, you enter the state of manipulating the heating-side output, and its value begins to increase.



Change in manipulated output when the dead band is positive

### ● Controller Behavior and Control Output Manipulation when the Dead Band is Negative



The following is an example when the DB parameter is set at -12.4%.

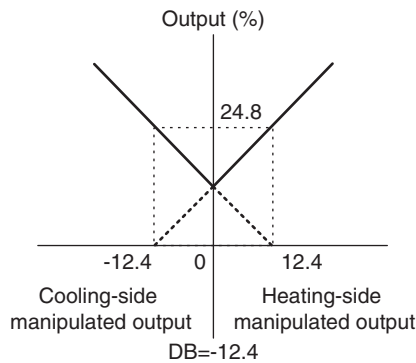

If you hold down the  key with the heating-side output under manipulation (i.e., cooling-side output C = 0.0%), the heating-side output (H =) decreases. If the output H falls below 24.8%, the cooling-side output C begins to increase from 0.0%. If you keep the  key held down longer and the output C rises above 24.8%, the output H goes to 0.0% and you enter the state of manipulating the cooling-side output.



Change in manipulated output when the dead band is negative

### ■ Manipulating the Control Output during Position Proportional Control

The controller continues to provide control output as long as the  or  key is being pressed.

-  key: Closes the valve.
-  key: Opens the valve.

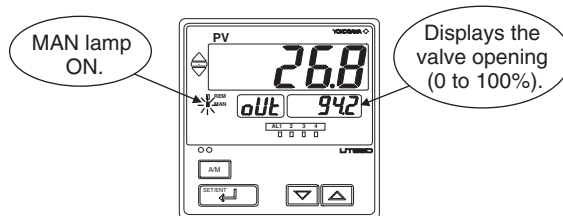

OUT display

Note : The output high limit (OH) and output low limit (OL) do not restrict the manual output of position proportional control.

## 3.10 Switching between Remote (REM) and Local (LCL)

The following operating procedure describes an example of switching from Local (LCL) to Remote (REM).

Switching between REM and LCL is possible for only controllers with remote input feature.

● Local

Performs control using target setpoints set in the controller.

● Remote

Performs control using external analog signals as target setpoints.

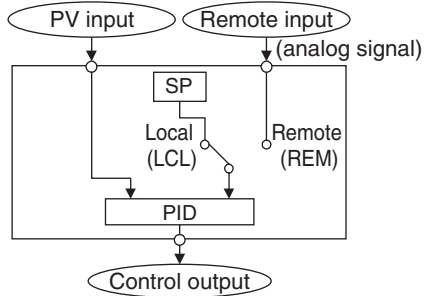

Note: The PID group number when the controller is in Remote operation is the same as the number set in the Target Setpoint Number (SPN) parameter.

 **NOTE**

If Remote state is achieved by external contact input (contact input is ON), switching between REM and LCL cannot be achieved by keystroke.

1. Bring the operating display into view (display appears at power on).

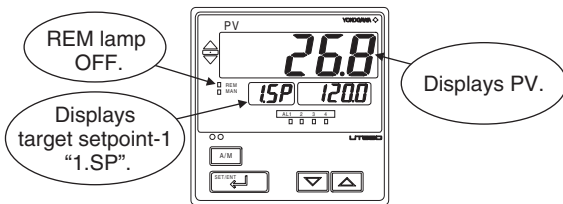

2. Press the  key for more than 3 seconds to call up the menu "OP.PA".

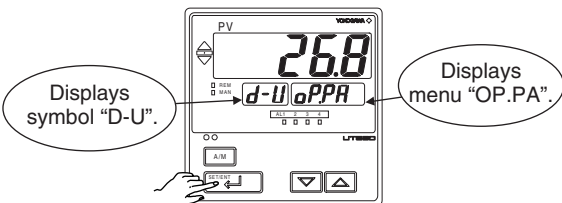

3. Press the  key several times to display the parameter "R/L".

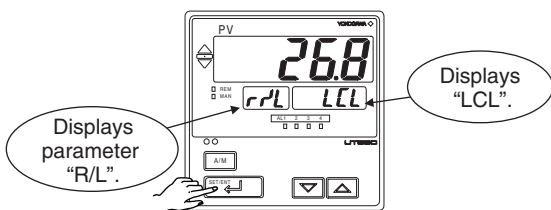

4. Press the  key to display "REM".

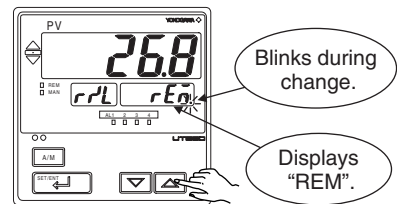

5. Press the  key once to register the setpoint.

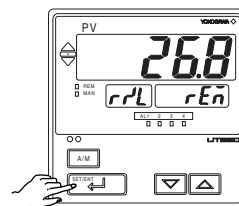

Automatically return to the display shown at power-on (figure below).

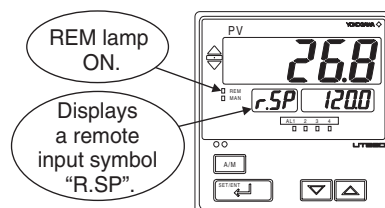

---

Blank Page



# 4. Troubleshooting and Maintenance

## 4.1 Troubleshooting

### ■ Troubleshooting Flow

If the operating display does not appear after turning on the controller's power, follow the measures in the procedure below.

If a problem appears complicated, contact our sales representative.

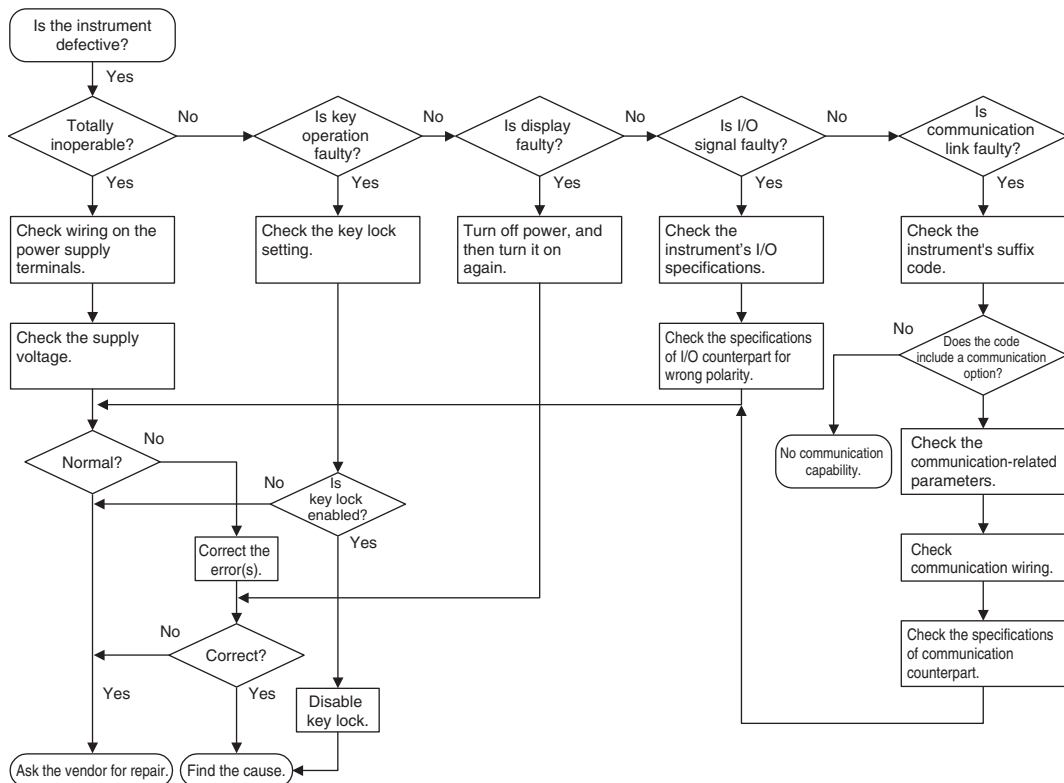

### IMPORTANT

Take note of the parameter settings when asking the vendor for repair.

## ■ Errors at Power on

The following table shows errors that may be detected by the fault diagnosis function when the power is turned on.

Error indication (on PV display unit)	Description of error	PV	Control output	Alarm output	Retransmission output	Communication	Remedy
<b>E000</b> (E000)	Faulty RAM	None	0% or less or OFF	OFF	0% or less	Stopped	Faulty Contact us for repair.
<b>E001</b> (E001)	Faulty ROM			Undefined	Undefined	Undefined	
<b>E002</b> (E002)	System data error	Undefined	Undefined	Undefined	Undefined		
PV decimal point blinks. 	Faulty calibration value	Normal action (out of accuracy)	Normal action (out of accuracy)	Normal action (out of accuracy)	Normal action (out of accuracy)	Normal action	Check and set the initialized parameters.
Error code (Note) (See description below.)	Parameter error	Normal action	Normal action	Normal action	Normal action	Normal action	

Note: An error code is displayed on the setpoint display unit.

An error code is displayed in the event of an error, according to its type.

An error code is a two-digit figure in which a combination of 6 bits of on and off is converted into a decimal number.

The following shows the relationship between each bit and parameter to be checked for abnormality.

Bit No.	6	5	4	3	2	1	0
Parameter to be checked	Operation mode/output	Operating parameters	Setup parameters	Range data	-	-	Calibration data

For example, if an error occurs with the operating parameter and calibration data, the error code will be as follows:

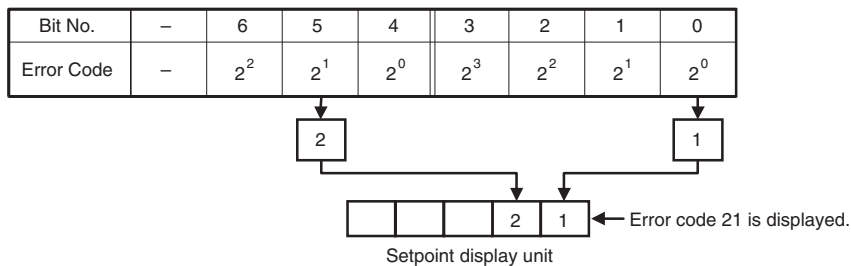

## ■ Possible Errors during Operation

The following shows possible errors occurring during operations.

Error indication (on PV display unit)	Description of error	PV	Control output	Alarm output	Retransmission output	Communication	Remedy								
Displays "RJC" and PV alternately	RJC error	Measured with RJC=OFF	Normal action	Normal action	Normal action	Normal action	Faulty Contact us for repair.								
Decimal point of item part in SP display unit blinks.	EEPROM error	Normal action													
<b>E300</b> (E300)	ADC error	105%	In AUTO: Preset value output In MAN: Normal action				Normal action	Normal action	Check wires and sensor.						
<b>boUt</b> (B.OUT)	PV burnout error	Dependent on the BSL parameter Up-scale: 105% Down-scale: -5%													
<b>oBEr</b> (OVER) or <b>-oBEr</b> (-OVER)	Excessive PV Out of -5 to 105%	-5% or 105%	Normal action				Normal action	Normal action	Check process.						
<b>E200</b> (E200)	Auto-tuning failure (Time-out)	Normal action	Action with PID existing before auto-tuning						Stopped	Normal action	Check process. Press any key to erase error indication.				
Setpoint display unit <table border="1" style="display: inline-table; vertical-align: middle;"><tr><td>-</td><td>-</td><td>-</td><td>-</td></tr></table>	-		-	-	-	Feedback resistor breakdown					Stopped	Check the feedback resistor.			
-	-	-	-												
Left end of SP display unit blinks.	Faulty communication line		Normal action	Normal action	Check wires and communication parameters, and make resetting. Recovery at normal receipt										
Decimal point at right end lights. <table border="1" style="display: inline-table; vertical-align: middle;"><tr><td> </td><td> </td><td> </td><td> </td><td> </td><td> </td><td> </td><td> </td></tr></table>									Runaway (due to defective power or noise)	Undefined	0% or less or OFF	OFF	0% or less	Stopped	Faulty if power off/on does not reset start the unit. Contact us for repair.
All indications off	Power off	None					Check for abnormal power.								

## ■ Remedies if Power Failure Occurs during Operations

The operation status and remedies after a power failure differ with the length of power failure time:

### ● Instantaneous Power Failure of 20 ms or less

A power failure is not detected. Normal operation continues.

### ● Power Failure of about 2 seconds or less

The following show effects caused in "settings" and "operation status."

Alarm action	Continues. Alarm with standby function will enter standby status.
Setting parameter	Set contents of each parameter are retained.
Auto-tuning	Cancelled.
Control action	Action before power failure continues.

● **Power Failure of more than about 2 seconds**

The following show effects caused in “settings” and “operation status.”

Alarm action	Continues. Alarm with standby function will enter standby status.	
Setting parameter	Set contents of each parameter are retained.	
Auto-tuning	Cancelled.	
Control action	Differs with setting of setup parameter “R.MD”(restart mode).	
	R.MD setting	Control action after recovery from power failure
	CONT	Continues action before power failure. (Factory-set default) For position-proportional type, when V.MD = Valve position estimating type, starts action from 0%.
	MAN	Outputs preset output value (PO) as control output and continues action set before power failure in MAN mode. For position-proportional type, when V.MD = Valve position feedback type, starts action from feedback input condition at recovery from power failure. When V.MD = Valve position estimating type, starts action from 0%. For heating/cooling control, starts action from heating-side output value and cooling-side output value of 50% of control computation output.
AUTO	Outputs preset output value (PO) as control output and continues action set before power failure in AUTO mode. For position-proportional type, when V.MD = Valve position feedback type, starts action from feedback input condition at recovery from power failure. When V.MD = Valve position estimating type, starts action from 0%. For heating/cooling control, starts action from heating-side output value and cooling-side output value of 50% of control computation output.	

## ■ Troubleshooting when the Controller Fails to Operate Correctly

If your control tasks are not successful, check the preset parameters and controller wiring before concluding the controller to be defective. The following show some examples of troubleshooting you should refer to in order to avoid the possibility of other problems.

### ● The Controller does not Show the Correct Measured Input (PV).

- The UT420/UT450 controllers have a universal input.  
The type of PV input can be set/changed using the parameter “IN”. At this point, the controller must be wired correctly according to the selected type of PV input. Check the wiring first if the controller fails to show the correct PV value. To do this, refer to “2. Initial Settings.”  
With the parameters “RH”, “RL”, “DP”, “SH” and “SL”, it is possible to scale the input signal and change its number of decimal places. Also check that these parameters are configured correctly.

### ● The Controller does not Provide any Control Output or the Control Output does not Change at all.

- The UT450/UT420 controllers have a universal output.  
The type of control output can be set/changed using the parameter “OT”.  
At this point, the controller must be wired correctly according to the selected type of control output. Check the wiring first if the controller provides no control output. To do this, refer to “1.5 Terminal Wiring Diagrams.”  
With the parameters “OH” and “OL”, it is possible to set/change the high and low limits of control output. The control output may not change at all, however, because of restrictions on these parameters. Also check the restrictions on these parameters.
- The control output can only be changed when the controller is in the MAN mode.  
If the MAN lamp is off (i.e., the controller is in the AUTO mode), you cannot change the control output using key operation.

### ● The Control Output does not Change soon after the Target Setpoint (SP) has been Changed.

- If this happens, check the setpoint of the parameter “MOD”. In cases where fixed-point control is selected as the PID control mode (MOD = 1), tracking based on the I-term works to prevent the control output from changing suddenly even if the target setpoint SP is varied.  
The control output therefore may appear to be working incorrectly at first; however it gradually adapts itself to the new target setpoint.

## 4.2 Maintenance

This section describes the cleaning and maintenance of the UT450/UT420.

### 4.2.1 Cleaning

The front panel and operation keys should be gently wiped with a dry cloth.



#### **NOTE**

---

Do not use alcohol, benzine, or any other solvents.

---

### 4.2.2 Replacing Brackets

When the brackets are broken or lost, purchase the following brackets for replacement.

Target Model	Part No.	Sales Unit
UT450	T9115NL	A large bracket and small bracket in pair
UT420	T9115NK	Small brackets in pair

#### **SEE ALSO**

---

“1.2 How to Install,” for how to replace brackets.

---

### 4.2.3 Attaching Terminal Cover

When a terminal cover is necessary, purchase the following part.

Target Model	Part No.	Sales Unit
UT450	T9115YD	1
UT420	T9115YE	1

#### ■ Attaching Terminal Cover

The procedure for attaching the terminal cover is as follows.



#### CAUTION

Do not touch the terminals on the rear panel when power is being supplied to the controller. Doing so may result in electric shock. Before attaching the terminal cover, turn off the source circuit breaker and use a tester to check that the power cable is not conducting any electricity.

1. Before attaching the terminal cover, fold it once or twice so that the side which has the "Handle With Care" symbol (⚠), is on the outside.

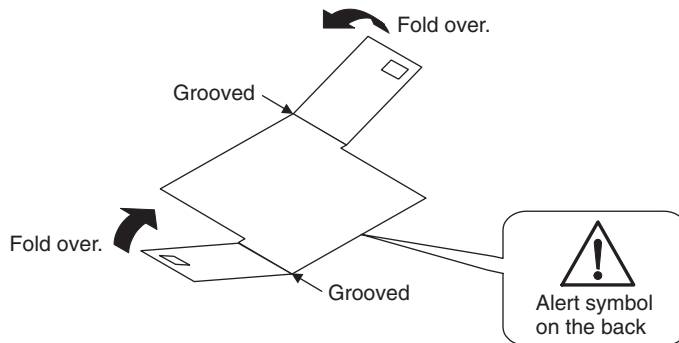

Folding Direction of Terminal Cover



#### NOTE

Do not fold the terminal cover the wrong way, doing so not only reduces the cover's strength but may also cause the hinge to crack, thereby disabling attachment.

2. With the cover properly folded, fit its top and bottom holes to the protrusions of the mounting brackets.

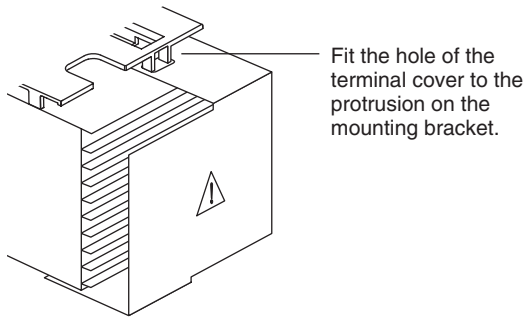

Attaching Terminal Cover

### 4.2.4 Replacing Parts with a Limited Service Life

The following UT450/UT420 parts have a limited service life. The service life given in the table assume that the controller is used under normal operating conditions.

Part	Service life
Aluminum electrolytic condenser	About 10 years (rated)
EEPROM	About 100,000 times of writings
Alarm output relays	About 100,000 more ON-OFF operations or with resistance load
Control output relays	About 100,000 more ON-OFF operations or with resistance load

If any of these parts, except control output relays, cause a controller failure due to deterioration, contact your dealer for replacement at your cost.

#### SEE ALSO

“4.2.5 Replacing Control Output Relays,” for how to replace the control output relays.



## 4.2.5 Replacing Control Output Relays

This subsection describes how to replace the control output relays.

Since inspection is needed in case parts are replacement will be carried out by a YOKOGAWA engineer or an engineer certified by YOKOGAWA. When replacement is required, contact your nearest YOKOGAWA dealer.



Always turn off the power before starting the work in order to avoid electric shock.

Do not pull out the internal unit for any other purpose other than to replace the control output relays.

1. **Insert a flat-blade screwdriver (tip width of 6 mm is recommended) into the opening with the tip in parallel with the front panel, and then turn the screwdriver gently. Take this procedure to four openings 1, 2, 3 and 4 (see the figure below) on the upper and lower parts of the bezel, in order. The bezel slightly moves forward from the housing.**

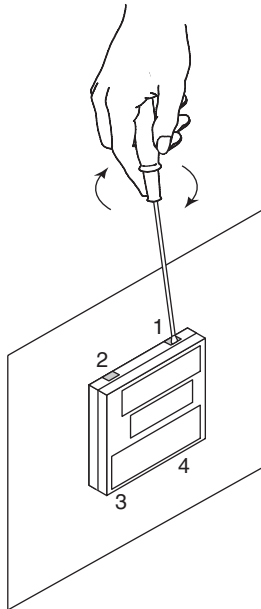

2. **Push up the center of the bottom gasket of bezel by a finger to release the latch.**

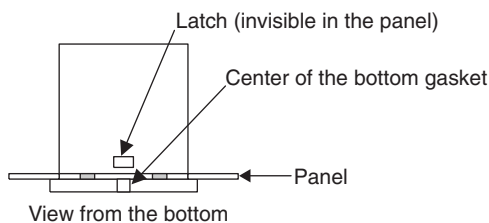

3. **Insert a flat-blade screwdriver into the four openings and flip the tip forward again to move the bezel more forward.**

- 4. Hold the bezel and pull it along with the internal unit out of the housing.  
(Note) Be careful not to damage the RJC sensor.

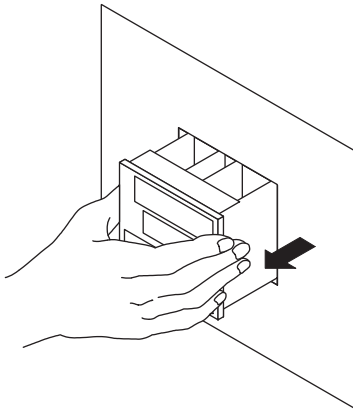

- 5. The location and number of the relays differ depending on the model code of the UT450/UT420.  
Confirm the location of the control output relay to be replaced before pulling out the relay.

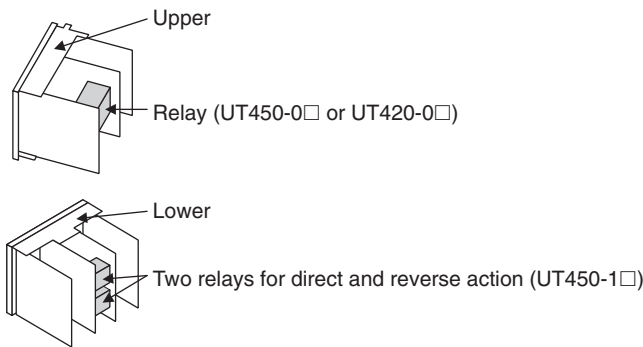

- 6. Pull out the relay to be replaced.  
The control output relays are easy to remove and mount, since they are connected via a socket onto the print boards.

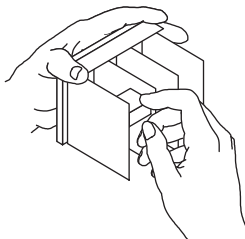

Insert the new relay in the socket. Use the following relay.

Manufacturer	OMRON
Model	G6B-2114P-FD-US-P6B
Power supply	12 V DC

- 7. Insert the internal unit into the housing.**  
Apply power to the controller and confirm that the initial operating display is shown. If the operating display is not shown properly, turn off the controller and pull out the internal unit. Then, insert it into the housing again.

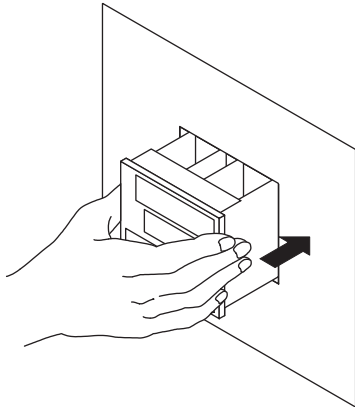

This completes replacement of the control output relay.

---

Blank Page

# 5. Parameters

## 5.1 Parameter Map

This section contains a parameter map as a guideline for setting parameters.

These maps helpful in finding the positions of the displays when setting the parameters, and should be used as a quick reference for the entire range of parameter displays.

UT450/UT420 Operating Parameter Map

Operating Display

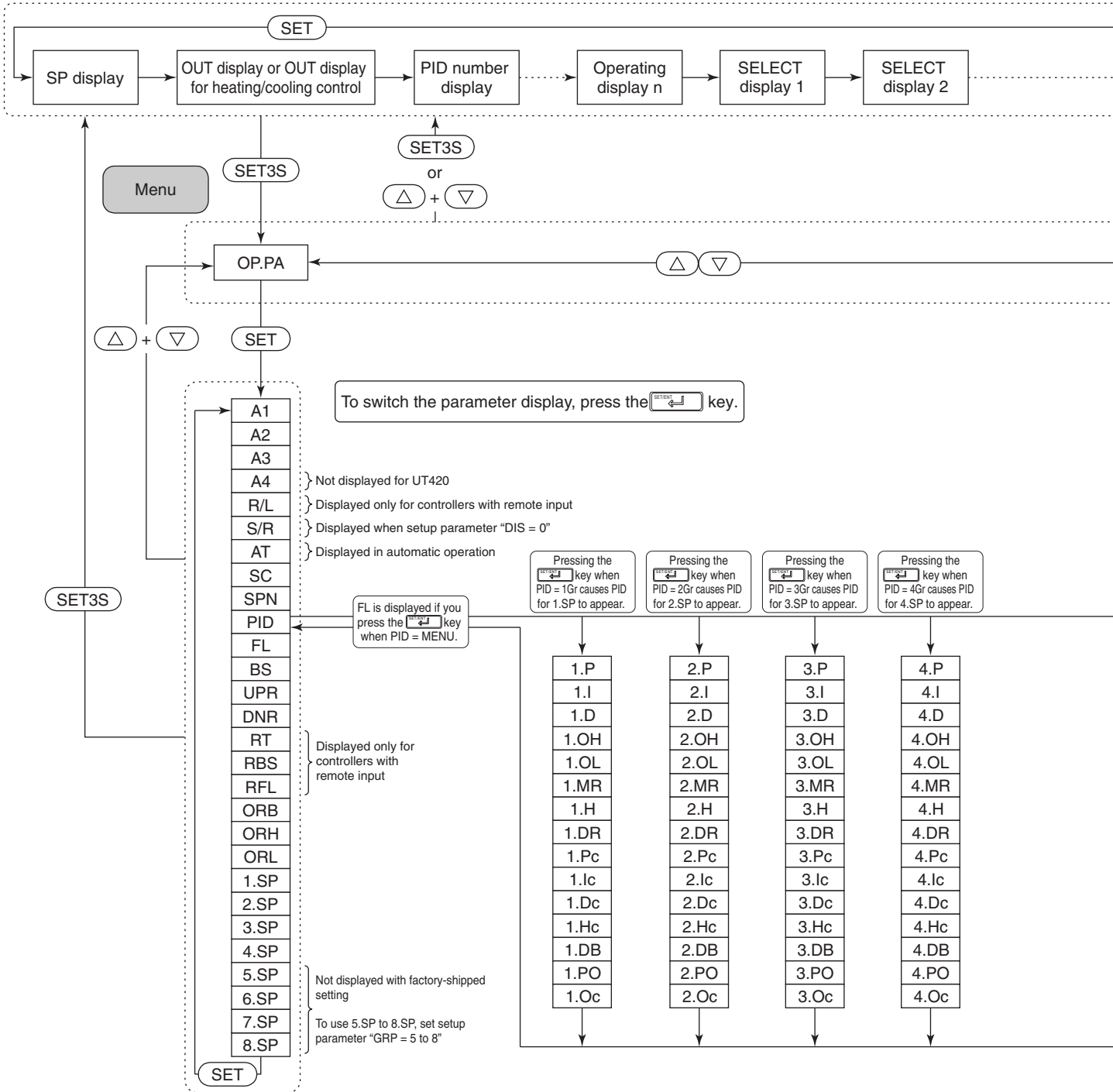

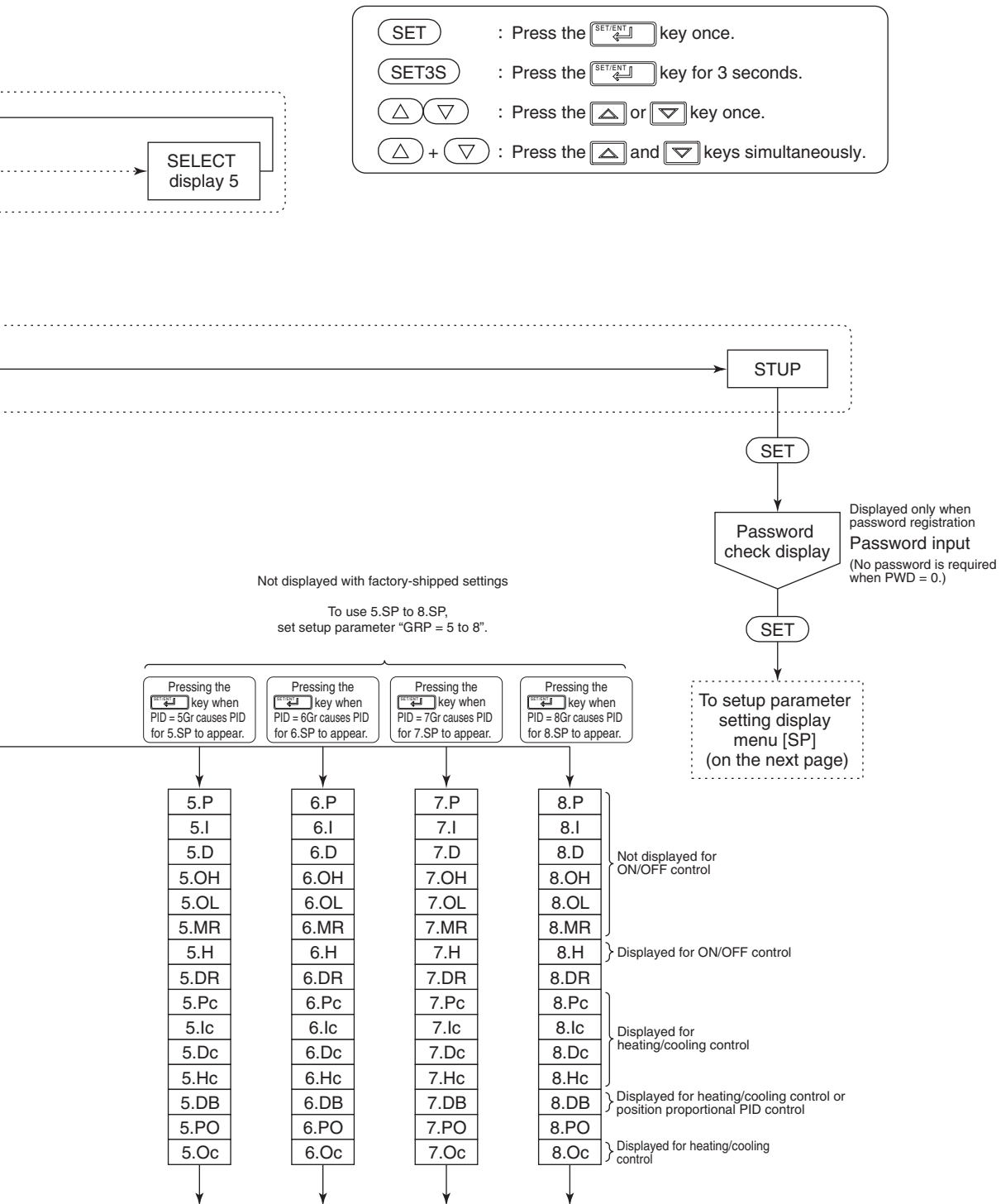

Pressing the (Δ) + (▽) keys once when a parameter setting display is shown retrieves the menu of that parameter setting display.

SELECT display 1 to 5 are shown only when they are registered.



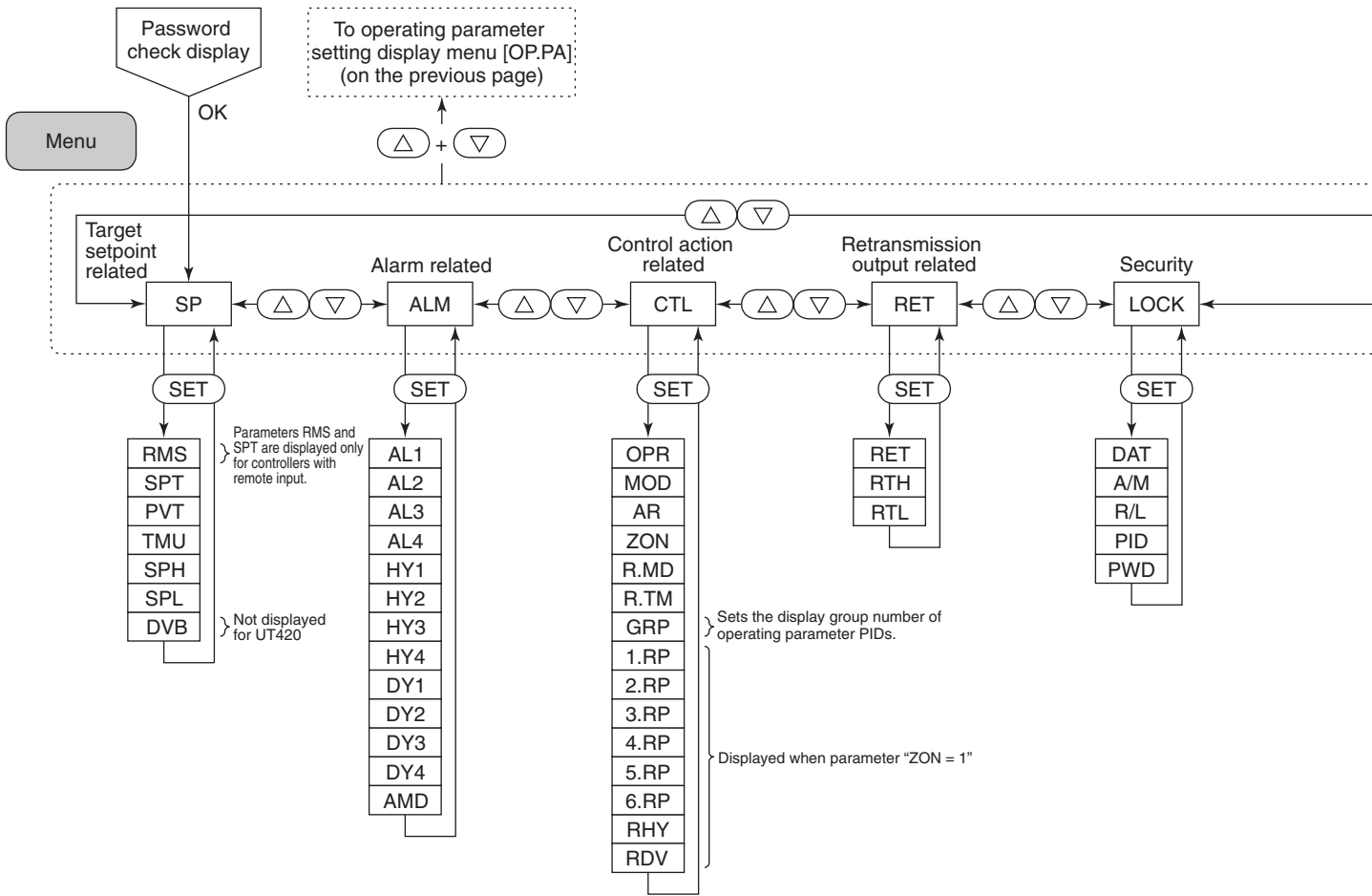

UT450/UT420 Setup Parameter Map







To switch parameter display, press the  key.



SET : Press the  key once.

  : Press the  or  key once.

 +  : Press the  and  keys simultaneously.

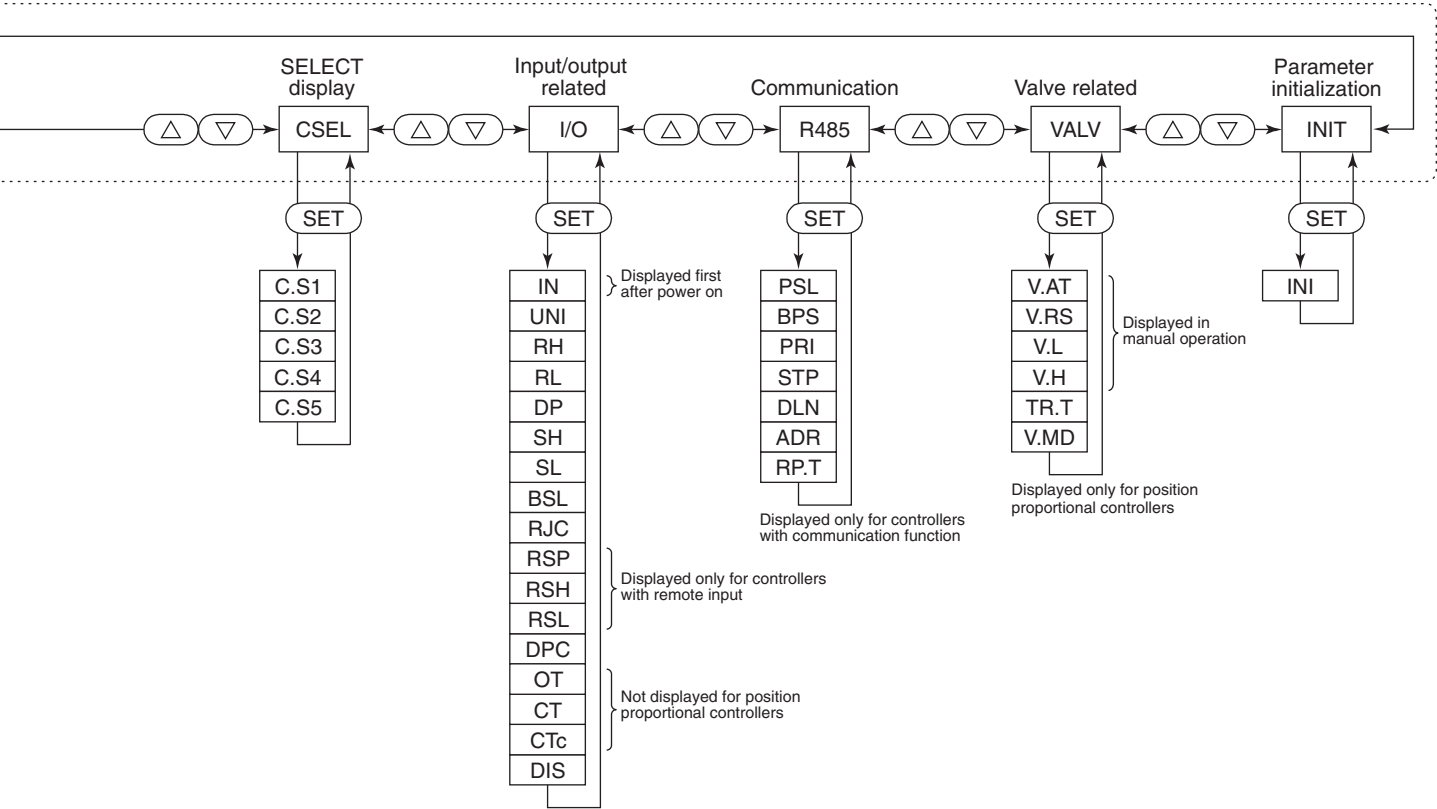

## 5.2 Lists of Parameters

This section describes the functions of parameters briefly. In addition, each parameter table has a “User Setting” column, where you can record your setpoints when setting them in the controller.

- \* Parameters relating to PV or setpoints should all be set in real numbers. For example, use temperature values to define target setpoints and alarm setpoints for temperature input.
- \* The “User Setting” column in the table is provided for the customer to record setpoints.
- \* The column “Target Item in CD-ROM” in the table provides references from User’s Manual (Reference) (CD-ROM Version) which describes items in more detail and items that are not contained in this manual.
- \* Numbers in ( ) are the parameter setpoints that apply when the communication function is used. ex. REM (1), LCL (0).

### ■ Operating Parameters

Parameter Symbol	Name of Parameter	Setting Range and Description	Initial Value	User Setting	Target Item in CD-ROM
<b>A1</b> (A1)	Alarm 1-setpoint	PV alarm / SP alarm: -100.0 to 100.0% of PV input range Deviation alarm: -100.0 to 100.0% of PV input range span Output alarm: -5.0 to 105.0% Timer alarm (for alarm 1 only): 0.00 to 99.59 (hour, min) or (min, sec) These Alarm setpoint parameters are common to the parameters 1.SP to 8.SP.	PV high limit/SP high limit alarm: 100.0% of PV input range Deviation alarm: 0.0% of PV input range span Other PV/SP low limit alarm: 0.0% of PV input range Output high limit alarm: 100.0% Output low limit alarm: 0.0%		Ref.4.1(1)
<b>A2</b> (A2)	Alarm 2-setpoint				same as above
<b>A3</b> (A3)	Alarm 3-setpoint				same as above
<b>A4</b> (A4)	Alarm 4-setpoint				same as above
<b>r r L</b> (R/L)	Remote/local switching	REM (0): remote operation LCL (1): local operation	LCL (0)		—
<b>S r r</b> (S/R)	Run/stop switching	Stop (1): operation stopped Run (0): operation started	RUN (0)		—
<b>At</b> (AT)	Auto-tuning	OFF (0): No auto-tuning 1: Auto-tuning for 1.SP 2: Auto-tuning for 2.SP 3: Auto-tuning for 3.SP 4: Auto-tuning for 4.SP 5 to 8: Perform auto-tuning on a group basis in the same way as 1 to 4 9: Performs auto-tuning to all groups 1 to 8.	OFF (0)		—
<b>SC</b> (SC)	“Super” function	OFF (0): Disable 1: Overshoot suppressing function Suppresses overshoots generated by abrupt changes in the target setpoint or by disturbances. 2: Hunting suppressing function (Stable mode) Suitable to stabilize the state of control when the load varies greatly, or the target setpoint is changed. Enables to answer the wider characteristic changes compared with Response mode. 3: Hunting suppressing function (Response mode) Enables quick follow-up and short converging time of PV for the changed target setpoint.  Note: Use “SUPER” function (SC) 2 or 3 in PID control or PI control. “SUPER” function 2 or 3 is not available in the following controls: 1) ON/OFF control 2) P control (control for proportional band only) 3) PD control (control for proportional band and derivative item only) 4) Heating/cooling control Do not use hunting suppressing function when control processes with response such as flow or pressure control.	OFF (0)		Ref.2.1(5) Ref.2.1(6)

Parameter Symbol	Name of Parameter	Setting Range and Description	Initial Value	User Setting	Target Item in CD-ROM
<b>SPn</b> (SPN)	Target setpoint number selection	1. Selects target setpoint 1 (1.SP). 2. Selects target setpoint 2 (2.SP). 3. Selects target setpoint 3 (3.SP). 4. Selects target setpoint 4 (4.SP). Likewise, numbers 5 to 8 can be specified to select target setpoints 5.SP to 8.SP.	1		—
<b>PI d</b> (PID)	PID parameter display number	MENU (0): Move to FL parameter display 1Gr (1) to 8Gr (8): Display of each PID parameter (factory-set to 1Gr to 4Gr)	MENU (0)		Ref.4.1(1)
<b>FL</b> (FL)	PV input filter	OFF (0), 1 to 120 second. Used when the PV input fluctuates.	OFF (0)		Ref.1.1(1)
<b>BS</b> (BS)	PV input bias	-100.0% to 100.0% of PV input range span Used to correct the PV input range.	0.0% of PV input range span		same as above
<b>UPr</b> (UPR)	Setpoint ramp-up-rate	OFF (0) 0.0% + 1 digit of PV input range span to 100.0% of PV input range span	OFF (0)		Ref.4.1(4)
<b>dnr</b> (DNR)	Setpoint ramp-down-rate	Set ramp-up-rate or ramp-down-rate per hour or minute. Sets unit in ramp-rate-time unit (TMU).	OFF (0)		same as above
<b>rt</b> (RT)	Ratio setting	0.001 to 9.999 Target setpoint = Remote input × Ratio setpoint + Remote bias	1.000		Ref.1.2(3)
<b>rbS</b> (RBS)	Remote input bias	-100.0 to 100.0% of PV input range span	0.0% of PV input range span		same as above
<b>rFL</b> (RFL)	Remote input filter	OFF (0), 1 to 120 second.	OFF (0)		same as above
<b>orb</b> (ORB)	ON/OFF rate detection band	0.0 to 100.0% of PV input range span	1.0% of PV input range span		Ref.3.3(4)
<b>orH</b> (ORH)	ON/OFF rate high limit	ORL + 1 digit to 105.0%	100.0%		same as above
<b>orL</b> (ORL)	ON/OFF rate low limit	-5.0% to ORH - 1 digit	0.0%		same as above
<b>1SP</b> (1.SP)	Target setpoint-1	0.0 to 100.0% of PV input range However, between target setpoint limiter lower limit (SPL) and upper limit (SPH).	0.0% of PV input range		Ref.4.1(1)
<b>2SP</b> (2.SP)	Target setpoint-2				same as above
<b>3SP</b> (3.SP)	Target setpoint-3				same as above
<b>4SP</b> (4.SP)	Target setpoint-4				same as above
<b>5SP</b> (5.SP)	Target setpoint-5	0.0 to 100.0% of PV input range Non-display in factory-shipped setting To display them, set setup parameter GRP (PID group number) to the number you wish to display.	0.0% of PV input range		same as above
<b>6SP</b> (6.SP)	Target setpoint-6				same as above
<b>7SP</b> (7.SP)	Target setpoint-7				same as above
<b>8SP</b> (8.SP)	Target setpoint-8				same as above

● PID-related Parameters

The following parameters are displayed when “1Gr” is set to PID parameter display number (PID). In this case, the corresponding target setpoint is 1.SP (target setpoint-1).

To set PID corresponding to target setpoint 2 to 4, set “2Gr”, “3Gr”, or “4Gr” to PID. The relevant parameters will then be displayed.

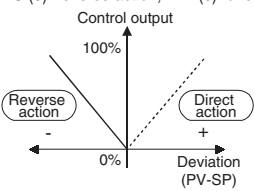
Parameter Symbol	Name of Parameter	Setting Range and Description	Initial Value	User Setting	Target Item in CD-ROM
<b>IP</b> (1.P)	Proportional band/Heating-side proportional band (in heating/cooling control)	0.1 to 999.9% In heating/cooling control: 0.0 to 999.9% (heating-side ON/OFF control applies when 0.0)	5.0%		Ref.4.1(1)
<b>I</b> (1.I)	Integral time Heating-side integral time (in heating/cooling control)	OFF (0), 1 to 6000 second.	240 second.		same as above
<b>Id</b> (1.D)	Derivative time Heating-side derivative time (in heating/cooling control)	OFF (0), 1 to 6000 second.	60 second.		same as above
<b>loH</b> (1.OH)	Output high limit Heating-side output high limit (in heating/cooling control)	-5.0 to 105.0% Heating-side limiter in heating/cooling control: 0.0 to 105.0% (1.OL < 1.OH)	100% Heating/cooling control: 100.0%		Ref.2.1(3)
<b>loL</b> (1.OL)	Output low limit Cooling-side output high limit (in heating/cooling control)	-5.0 to 105.0% Cooling-side limiter in heating/cooling control: 0.0 to 105.0% (1.OL < 1.OH) SD (shutdown): Set in manual operation in 4-20 mA control output. The control output is set at 0 mA.	0.0% Heating/cooling control: 100.0%		Ref.4.1(1)
<b>lMr</b> (1.MR)	Manual reset	-5.0 to 105.0% (enabled when integral time “1.I” is OFF) The manual reset value equals the output value when PV = SP is true. For example, if the manual reset value is 50%, the output value is 50% when PV = SP becomes true.	50.0%		Ref.4.1(1)
<b>IH</b> (1.H)	ON/OFF control hysteresis Heating-side ON/OFF control hysteresis (in heating/cooling control)	In ON/OFF control: 0.0 to 100.0% of PV input range span Position proportional PID control or heating/cooling control: 0.0 to 100.0%	ON/OFF control: 0.5% of PV input range span Position proportional PID control and heating/cooling control: 0.5%		same as above
<b>ldr</b> (1.DR)	Direct/reverse action switching	RVS (0): reverse action, DIR (0): direct action 	RVS (0)		Ref.2.1(1) Ref.4.1(1)
<b>IPc</b> (1.Pc)	Cooling-side proportional band	0.0 to 999.9% (Cooling-side ON/OFF control applies when 0.0)	5.0%		Ref.4.1(1)
<b>Ic</b> (1.Ic)	Cooling-side integral time	OFF (0), 1 to 6000 second	240 second.		same as above
<b>Idc</b> (1.Dc)	Cooling-side derivative time	OFF (0), 1 to 6000 second	60 second.		same as above
<b>Ihc</b> (1.Hc)	Cooling-side ON/OFF control hysteresis	0.0 to 100.0%	0.5%		same as above
<b>ldb</b> (1.DB)	Dead band	In heating/cooling control: -100.0 to 50.0% In position proportional PID control: 1.0 to 10.0%	3.0%		same as above
<b>IPo</b> (1.PO)	Preset output/Heating-side preset output (in heating/cooling control)	-5.0 to 105.0% In heating/cooling control: Heating side 0.0 to 105.0% In Stop state, fixed control output can be generated.	0.0%		Ref.2.1(8)
<b>loc</b> (1.Oc)	Cooling-side preset output	0.0 to 105.0% In Stop state, cooling-side fixed control output can be generated.	0.0%		Ref.4.1(1)

Refer to the table below for recording setpoints when two sets or more of PID parameters are used.

Parameter	n=2	n=3	n=4	n=5	n=6	n=7	n=8
n.P							
n.I							
n.D							
n.OH							
n.OL							
n.MR							
n.H							
n.DR							
n.Pc							
n.Ic							
n.Dc							
n.Hc							
n.DB							
n.PO							
n.Oc							

## ■ Setup Parameters

### ● Target Setpoint-related Parameters

Parameter Symbol	Name of Parameter	Setting Range and Description	Initial Value	User Setting	Target Item in CD-ROM
<b>rñs</b> (RMS)	Remote input selection	RSP (0): Remote setpoints are used via remote input (terminals). COM (1): Remote setpoints are used via communication.	RSP (0)		Ref.1.2(1)
<b>SPT</b> (SPT)	SP tracking selection	OFF (0), ON (1) Tracking is performed when the mode changes from Remote to Local (the local setpoint keeps track of the remote setpoint).	ON (1)		Ref.1.2(4)
<b>PVT</b> (PVT)	PV tracking selection	OFF (0), ON (1) Uses a combination of the setpoint ramp-up rate (UPR) and setpoint ramp-down rate (DNR) parameters. Operating conditions: [1] Manual operation -> Automatic operation [2] Stop of operation -> Start of automatic operation [3] Power-on [4] Changing of SP number [5] Does not work when the target setpoint is changed	OFF (0)		Ref.1.1(7)
<b>tmu</b> (TMU)	Ramp-rate time unit setting	HOUR (1), MIN (0) Time unit of setpoint ramp-up rate (UPR) and setpoint ramp-down rate (DNR)	HOUR (1)		Ref.4.1(4)
<b>SPH</b> (SPH)	Target setpoint limiter upper limit	0.0 to 100.0% of PV input range where, SPL < SPH Places a limit on the range within which the target setpoint is changed.	100.0% of PV input range		—
<b>SPL</b> (SPL)	Target setpoint limiter lower limit		0.0% of PV input range		—
<b>dδb</b> (DVB)	Deviation display band (UT450 only)	0.0 to 100.0% of PV input range span	1.0% of PV input range span		Ref.6.1(3)

● Alarm-related Parameters

Parameter Symbol	Name of Parameter	Setting Range and Description	Initial Value	User Setting	Target Item in CD-ROM	
<b>AL1</b> (AL1)	Alarm-1 type	OFF (0), 1 to 31 (same as below)	1		Ref.3.3(3) Ref.3.3(4)	
<b>AL2</b> (AL2)	Alarm-2 type	OFF (0), 1 to 20, 25 to 31 1: PV high limit (energized, no stand-by action) 2: PV low limit (energized, no stand-by action)	2		Ref.3.3(4)	
<b>AL3</b> (AL3)	Alarm-3 type	3: Deviation high limit (energized, no stand-by action) 4: Deviation low limit (energized, no stand-by action) 5: Deviation high limit (de-energized, no stand-by action) 6: Deviation low limit (de-energized, no stand-by action) For other alarm types, see "2.7 Changing Alarm Type." These Alarm Type parameters are common to the parameters 1.SP to 8.SP.	1		same as above	
<b>AL4</b> (AL4)	Alarm-4 type		2		same as above	
<b>HY1</b> (HY1)	Alarm-1 hysteresis	<p>Hysteresis for PV high limit alarm</p>	0.5% of PV input range span Output alarm: 0.5%		Ref.3.3(2)	
<b>HY2</b> (HY2)	Alarm-2 hysteresis					same as above
<b>HY3</b> (HY3)	Alarm-3 hysteresis					same as above
<b>HY4</b> (HY4)	Alarm-4 hysteresis					same as above
<b>DY1</b> (DY1)	Alarm-1 delay timer	An alarm is output when the delay timer expires after the alarm setpoint is reached. 0.00 to 99.59 (min, sec.) (enabled when alarm-1 type "AL1" is 1 to 20 or 28 to 31)	0.00			
					—	
<b>DY2</b> (DY2)	Alarm-2 delay timer	0.00 to 99.59 (min, sec.) (enabled when alarm-2 type "AL2" is 1 to 20 or 28 to 31)			—	
<b>DY3</b> (DY3)	Alarm-3 delay timer	0.00 to 99.59 (min, sec.) (enabled when alarm-3 type "AL3" is 1 to 20 or 28 to 31)			—	
<b>DY4</b> (DY4)	Alarm-4 delay timer	0.00 to 99.59 (min, sec.) (enabled when alarm-4 type "AL4" is 1 to 20 or 28 to 31)			—	
<b>AMD</b> (AMD)	Alarm mode	Allows the alarm function to be enabled or disabled according to the operating condition. 0: Always active 1: Not active when in Stop mode 2: Not active when in Stop mode or manual operation	0		Ref.3.3(1)	

● Control Action-related Parameters

Parameter Symbol	Name of Parameter	Setting Range and Description	Initial Value	User Setting	Target Item in CD-ROM
<i>opr</i> (OPR)	Output velocity limiter	OFF (0) 0.1 to 100.0%/second. can limit control output velocity	OFF (0)		—
<i>mod</i> (MOD)	PID control mode	0: Standard PID control (with output bump at SP change) 1: Fixed value control (without output bump at SP change) Choose "Fixed Value Control" when controlling pressure or flow rate.	0		Ref.2.1(2)
<i>Ar</i> (AR)	Anti-reset windup (Excess integration prevention)	AUTO (0), 50.0 to 200.0% Used when the control output travels up to 100% or down to 0% and remains there. The larger SP, the sooner PID computation (integral computation) stops.	AUTO (0)		Ref.2.1(4)
<i>zon</i> (ZON)	Zone PID selection	0: SP selection 1: Zone PID	0		Ref.4.1(2)
<i>r.nd</i> (R.MD)	Restart mode	CONT (0): Continues action set before power failure. MAN (1): Starts from manual operation status AUTO (2): Continues action set before power failure in automatic operation.	CONT (0)		—
<i>r.tn</i> (R.TM)	Restart timer	0 to 10 second. Sets time between power on and the instant where controller starts computation.	0 second.		—
<i>GrP</i> (GRP)	PID group number	1 to 8 Determines operating parameter PID display group number.	4		Ref.4.1(1)
<i>1.rP</i> (1.RP)	Zone PID reference point-1	0.0 to 100.0% of PV input range. Note that 1.RP ≤ 2.RP ≤ 3.RP ≤ 4.RP ≤ 5.RP ≤ 6.RP. Set ZON PID selection (ZON) parameter to "1".	100% value of PV input range		Ref.4.1(2)
<i>2.rP</i> (2.RP)	Zone PID reference point-2	<p>The example below sets reference points 1 and 2 to provide 3 zones to switch PID constants automatically. A maximum of 7 zones are settable.</p>		same as above	
<i>3.rP</i> (3.RP)	Zone PID reference point-3			same as above	
<i>4.rP</i> (4.RP)	Zone PID reference point-4			same as above	
<i>5.rP</i> (5.RP)	Zone PID reference point-5			same as above	
<i>6.rP</i> (6.RP)	Zone PID reference point-6			same as above	
<i>rHY</i> (RHY)	Zone switching hysteresis		0.0 to 10.0% of PV input range span Allows a hysteresis to be set for switching at a reference point.	0.5% of PV input range span	
<i>rdv</i> (RDV)	Reference deviation	OFF (0), 0.0 to 100.0% of PV input range span Used to select PID constants according to a deviation from the setpoint. The maximum group of PID constants is used when the controller fails to keep track of the deviation.	OFF (0)		same as above



## ● Retransmission Output Parameters

Parameter Symbol	Name of Parameter	Setting Range and Description	Initial Value	User Setting	Target Item in CD-ROM
<b>rEt</b> (RET)	Retransmission output type	OFF (0): Disable 1: PV, 2: SP, 3: OUT 4: Loop power supply for sensor (15 V) In position proportional control, a valve opening signal (0 to 100%) is transmitted if setpoint "3" is selected. In heating/cooling control, an output value before allocation to heating and cooling control (0 to 100%) is transmitted if setpoint "3" is selected (0 to 50%: Cooling-side output; 50 to 100%: Heating-side output).	1		Ref.2.2(1) Ref.2.2(3)
<b>rEH</b> (RTH)	Max. value of retransmission output scale	RET=1, 2: RTL + 1 digit to 100.0% of PV input range	100.0% of PV input range		Ref.2.2(1)
<b>rEL</b> (RTL)	Min. value of retransmission output scale	RET=1, 2: 0.0% of PV input range to RTH - 1 digit	0.0% of PV input range		same as above

## ● Security-related Parameters



Parameter Symbol	Name of Parameter	Setting Range and Description	Initial Value	User Setting	Target Item in CD-ROM
<b>dAt</b> (DAT)	Front panel data setting ( $\Delta$ , $\nabla$ ) key lock	OFF (0), ON (1)	OFF (0)		Ref.7.1(2)
<b>Arn</b> (A/M)	Front panel A/M key lock	OFF (0), ON (1)	OFF (0)		same as above
<b>rRl</b> (R/L)	Lock of Remote/Local switching parameter	OFF (0), ON (1)	OFF (0)		same as above
<b>PId</b> (PID)	Lock of parameter for PID parameter display number	OFF (0), ON (1)	OFF (0)		same as above
<b>PuD</b> (PWD)	Password setting	0: Password not set 1 to 30000	0		Ref.7.1(1)

## ● SELECT Display Parameters

Parameter Symbol	Name of Parameter	Setting Range and Description	Initial Value	User Setting	Target Item in CD-ROM
<b>C51</b> (C.S1)	SELECT display-1 registration	OFF (0), 201 to 1023	OFF (0)		Ref.6.1(1)
<b>C52</b> (C.S2)	SELECT display-2 registration	Select the desired parameter from among the operating and setup parameters, then register the number (D register No.) accompanying that parameter.  For example, registering "231 for C.S1 allows you to change alarm-1 setpoint in operating display.			same as above
<b>C53</b> (C.S3)	SELECT display-3 registration	Numbers for registering alarm SP parameter for operating display:			same as above
<b>C54</b> (C.S4)	SELECT display-4 registration	Alarm-1 setpoint: 231      Alarm-2 setpoint: 232 Alarm-3 setpoint: 233      Alarm-4 setpoint: 234 Above numbers are alarm setpoint parameters for target setpoint-1 (1.SP).			same as above
<b>C55</b> (C.S5)	SELECT display-5 registration				same as above

## ● Input-/Output-related Parameters

Parameter Symbol	Name of Parameter	Setting Range and Description	Initial Value	User Setting	Target Item in CD-ROM
<b>IN</b> (IN)	PV input type (PV INPUT terminals) ①-⑫-⑬ terminals	OFF (0), 1 to 18, 30, 31, 35 to 37, 40, 41, 50, 51, 55, 56 See Instrument Input Range Codes in "2. Initial Settings."	OFF (0)		—
<b>UNI</b> (UNI)	PV input unit	% (0): Percent °F (5): Fahrenheit °C (1): degree Celsius - (2): No unit	°C (1)		—
<b>RH</b> (RH)	Max. value of PV input range	Set the PV input range, however RL < RH - Temperature input Set the range of temperature that is actually controlled. - Voltage input	Max. value of instrument input range		—
<b>RL</b> (RL)	Min. value of PV input range	Set the range of a voltage signal that is applied. The scale across which the voltage signal is actually controlled should be set using the parameters Maximum Value of PV Input Scale (SH) and Minimum Value of PV Input Scale (SL).	Min. value of instrument input range		—
<b>DP</b> (DP)	PV input decimal point position (displayed at voltage input)	0 to 4 Set the position of the decimal point of voltage-mode PV input.	2		—
<b>SH</b> (SH)	Max. value of PV input scale (displayed at voltage input)	-19999 to 30000, however SL < SH, SH-SL ≤ 30000 Set the read-out scale of voltage-mode PV input.	100.00		—
<b>SL</b> (SL)	Min. value of PV input scale (displayed at voltage input)		0.00		—
<b>BSL</b> (BSL)	Selection of PV input burnout action	OFF (0) UP (1): Up scale DOWN (2): Down scale	-		—
<b>RJC</b> (RJC)	Presence/absence of PV input reference junction compensation	OFF (0), ON (1)	-		—
<b>RSP</b> (RSP)	Remote input type (RSP INPUT terminals) ⑲-⑳ terminals	40, 41, 50, 51 See Instrument Input Range Codes in "2. Initial Settings."	41		Ref.1.2(1)
<b>RSH</b> (RSH)	Max. value of remote setting input scale	-19999 to 30000 However, RSL < RSH, RSH-RSL ≤ 30000	Max. value of PV input range or that of PV input scale		same as above
<b>RSL</b> (RSL)	Min. value of remote setting input scale	Set RSL and RSH in a range of RL to RH or SL to SH.	Min. value of PV input range or that of PV input scale		same as above
<b>DPC</b> (DPC)	Selection of non-display of figures below PV input decimal point	OFF (0), ON (1) For second decimal place, figures up to the first decimal place are shown.	OFF (0)		—

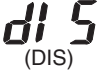
Parameter Symbol	Name of Parameter	Setting Range and Description	Initial Value	User Setting	Target Item in CD-ROM	
 (OT)	Control output type	0 Time proportional PID relay contact output (terminals ①-②-③)	0 Heating/cooling type: 4		—	
		1 Time proportional PID voltage pulse output (terminals ⑬-⑭)				
		2 Current output (terminals ⑬-⑭)				
		3 ON/OFF control relay contact output (terminals ①-②-③)				
		The following 4 to 12 are displayed only for heating/cooling type controllers.				
		4 Heating-side relay output (terminals ①-②-③), cooling-side relay output (terminals ④⑧-④⑨-④⑩)				
		5 Heating-side pulse output (terminals ⑬-⑭), cooling-side relay output (terminals ④⑧-④⑨-④⑩)				
		6 Heating-side current output (terminals ⑬-⑭), cooling-side relay output (terminals ④⑧-④⑨-④⑩)				
		7 Heating-side relay output (terminals ①-②-③), cooling-side pulse output (terminals ④⑥-④⑦)				
		8 Heating-side pulse output (terminals ⑬-⑭), cooling-side pulse output (terminals ④⑥-④⑦)				
		9 Heating-side current output (terminals ⑬-⑭), cooling-side pulse output (terminals ④⑥-④⑦)				
		10 Heating-side relay output (terminals ①-②-③), cooling-side current output (terminals ④⑥-④⑦)				
		11 Heating-side pulse output (terminals ⑬-⑭), cooling-side current output (terminals ④⑥-④⑦)				
12 Heating-side current output (terminals ⑬-⑭), cooling-side current output (terminals ④⑥-④⑦)						
 (CT)	Control output cycle time	1 to 1000 second.	30 second.		Ref.3.3(4)	
	Heating-side control output cycle time in heating/cooling control					
 (CTc)	Cooling-side control output cycle time	1 to 1000 second.	30 second.		same as above	
 (DIS)	DI function selection (Note)  UT420 can not switch the five or more of target setpoints by external contact input, because it does not have DI4 to DI6.	0 R/L = Remote (ON) / local (OFF)	1		Ref.3.1(2)	
		1 DI1 = Auto (ON) / Man (OFF) DI2 = Stop (ON) / Run (OFF) DI3 to DI6 = Switching between 1.SP to 8.SP R/L = Remote (ON) / local (OFF)				
		2 DI1 = Auto (ON) / Man (OFF) DI2 = 2.SP (ON) / 1.SP (OFF) DI3 = Stop (ON) / Run (OFF) R/L = Remote (ON) / local (OFF)				
		3 DI1 = Stop (ON) / Run (OFF) DI2 = 2.SP (ON) / 1.SP (OFF) DI3 = Auto (ON) / Man (OFF) R/L = Remote (ON) / local (OFF)				
		4 DI1, DI2 = Switching between 1.SP to 4.SP DI3 = Stop (ON) / Run (OFF) DI4 = Auto (ON) / Man (OFF) R/L = Remote (ON) / local (OFF)				

Note: External Contact Input

If the power is turned on when the external contact input is OFF, the mode (SPN, R/L, or A/M) existing before the power is turned off will be continued. (except for RUN/STOP)

• External contact-based SP selection when DIS = 1 is set

	DI3	DI4	DI5	DI6
1.SP	ON	OFF	OFF	OFF
2.SP	OFF	ON	OFF	OFF
3.SP	ON	ON	OFF	OFF
4.SP	OFF	OFF	ON	OFF
5.SP	ON	OFF	ON	OFF
6.SP	OFF	ON	ON	OFF
7.SP	ON	ON	ON	OFF
8.SP	OFF	OFF	OFF	ON

• SP selection when DIS = 4 is set

	DI1	DI2
1.SP	OFF	OFF
2.SP	ON	OFF
3.SP	OFF	ON
4.SP	ON	ON

● Communication Parameters

Parameter Symbol	Name of Parameter	Setting Range and Description	Initial Value	User Setting	Target Item in CD-ROM
<b>PSL</b> (PSL)	Protocol selection	0: PC link communication 1: PC link communication (with sum check) 2: Ladder communication 3: Coordinated master station 4: Coordinated slave station 7: MODBUS (ASCII) 8: MODBUS (RTU) 10: Coordinated slave station (loop-1 mode) 11: Coordinated slave station (loop-2 mode) (10, 11: When the master station is in dual-loop control, the slave station selects either of the loops to be controlled.)	0		Communication functions
<b>bPS</b> (BPS)	Baud rate	600 (0), 1200 (1), 2400 (2), 4800 (3), 9600 (4) (bps)	9600 (4)		
<b>PrI</b> (PRI)	Parity	NONE (0): None EVEN (1): Even ODD (2): Odd	EVEN (1)		
<b>StP</b> (STP)	Stop bit	1, 2	1		
<b>dLn</b> (DLN)	Data length	7, 8: Fixed at 7, when the PSL parameter is set to MODBUS (ASCII). Fixed at 8, when the PSL parameter is set to MODBUS (RTU) or Ladder Communication.	8		
<b>Adr</b> (ADR)	Address	1 to 99 However, the maximum number of stations connectable is 31.	1		
<b>rPt</b> (RP.T)	Minimum response time	0 to 10 (× 10 ms)	0		

## ● Motor-driven Valve Calibration-related Parameters (Displayed for Position Proportional Controllers)

Parameter Symbol	Name of Parameter	Setting Range and Description	Initial Value	User Setting	Target Item in CD-ROM
<b>VAT</b> (V.AT)	Automatic valve adjustment	Automatically adjusts the fully-closed and fully-open positions of a valve. When this function is used, there is no need for adjustment using the parameters V.RS, V.L and V.H. OFF (0): - ON (1): Start automatic adjustment	OFF (0)		—
<b>VRS</b> (V.RS)	Valve position setting reset	The parameters V.RS, V.L and V.H are designed for manual adjustment of valve positions. Setting V.RS to 1 resets the valve adjustment settings and causes the indication "V.RS" to blink.	0		—
<b>VL</b> (V.L)	Fully-closed valve position setting	Pressing the SET/ENT key with valve position set to the fully-closed position causes the adjusted value to be stored.	Undefined		—
<b>VH</b> (V.H)	Fully-opened valve position setting	Pressing the SET/ENT key with valve position set to the fully-opened position causes the adjusted value to be stored. When V.H adjustment is complete, V.H stops blinking.	Undefined		—
<b>TRT</b> (TR.T)	Valve action time	5 to 300 sec. Used to operate a valve according to the estimated valve position. Set the time required for the valve to open fully from a state of being fully closed. Confirm the valve action time by consulting the datasheet of the valve's specifications. The valve action time is only effective when Valve Adjustment Mode (V.MD) is set to 1 or 2.	60 sec.		—
<b>VMD</b> (V.MD)	Valve adjusting mode	0: Valve position feedback type 1: Valve position feedback type (moves to the estimating type if a valve input error or burnout occurs.) 2: Valve position estimating type	0		—

---

Blank Page

---

## 6. Function Block Diagram and Descriptions

This chapter contains the function block diagrams for “Standard Type,” “Heating/Cooling Type,” and “Position Proportional Type.” For details on these function block diagrams, refer to the descriptions mentioned later.

In the function block diagram for “Standard Type,” some contact input/output that UT420 does not have appear. Refer to the function block diagram after confirming the presence/absence of the contact input/output.

■ Function Block Diagram for Standard Type (UT450/UT420)

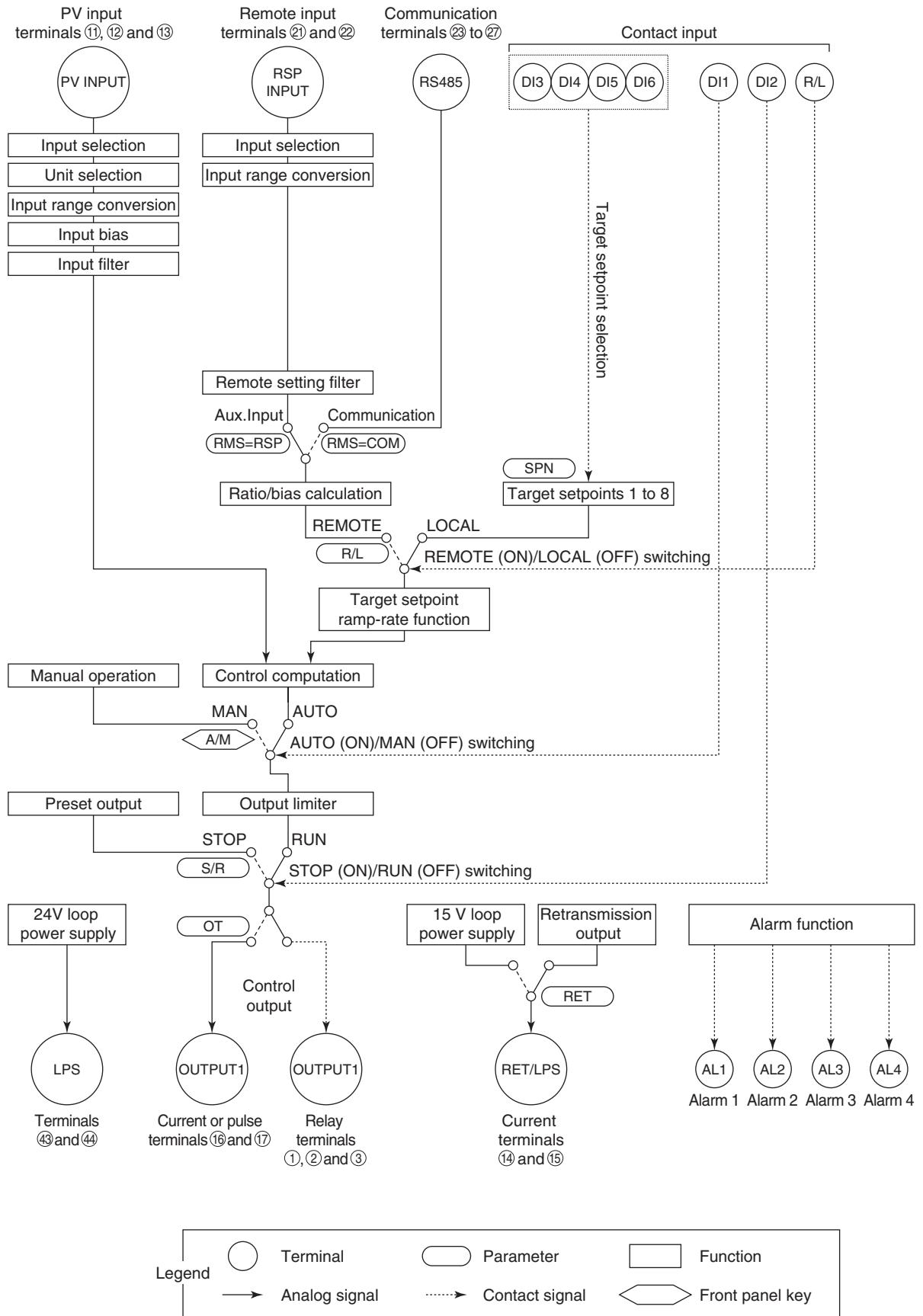



### ■ Function Block Diagram for Heating/Cooling Type (UT450/UT420)

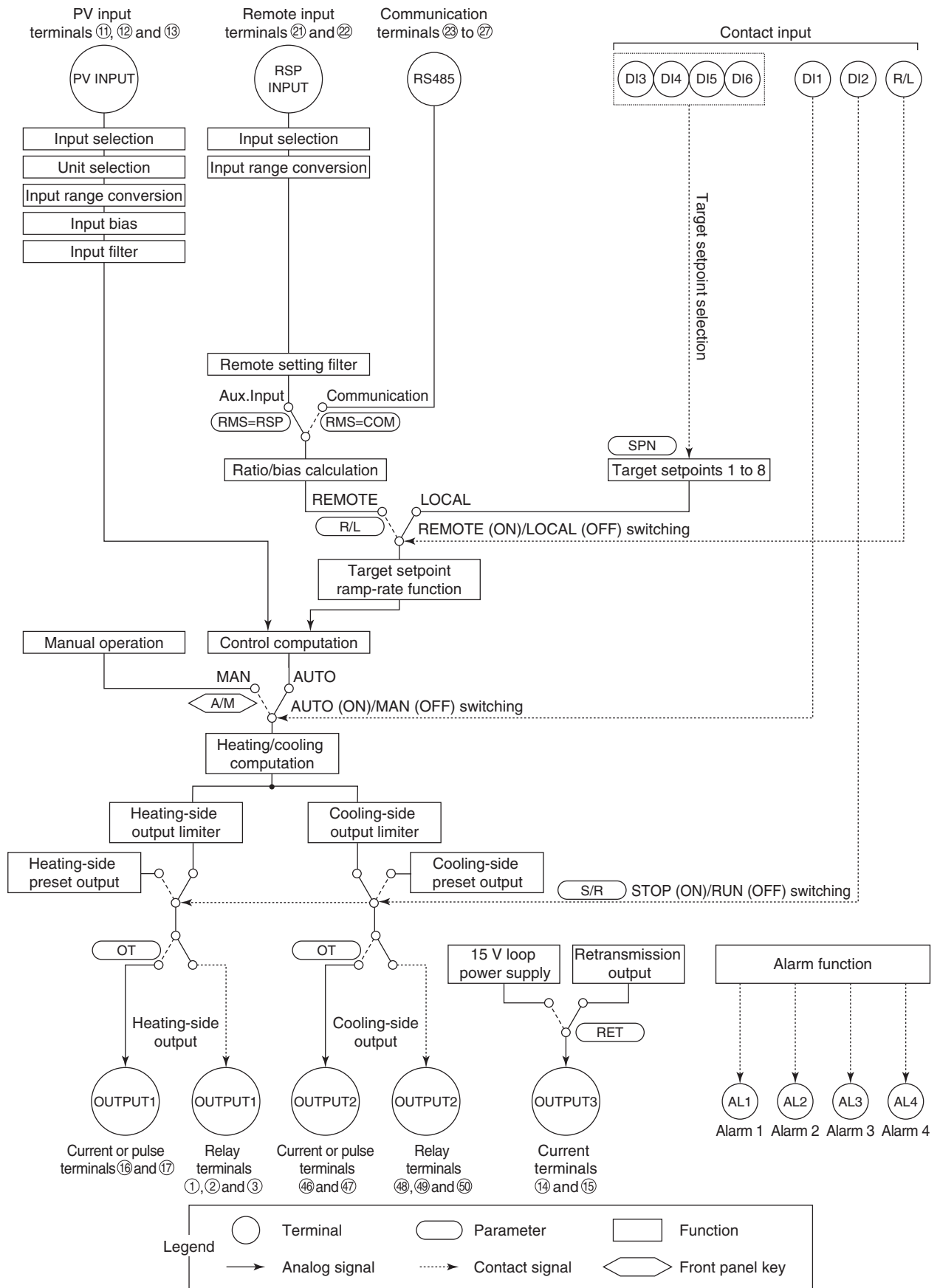

# Function Block Diagram for Position Proportional Type (UT450/UT420)

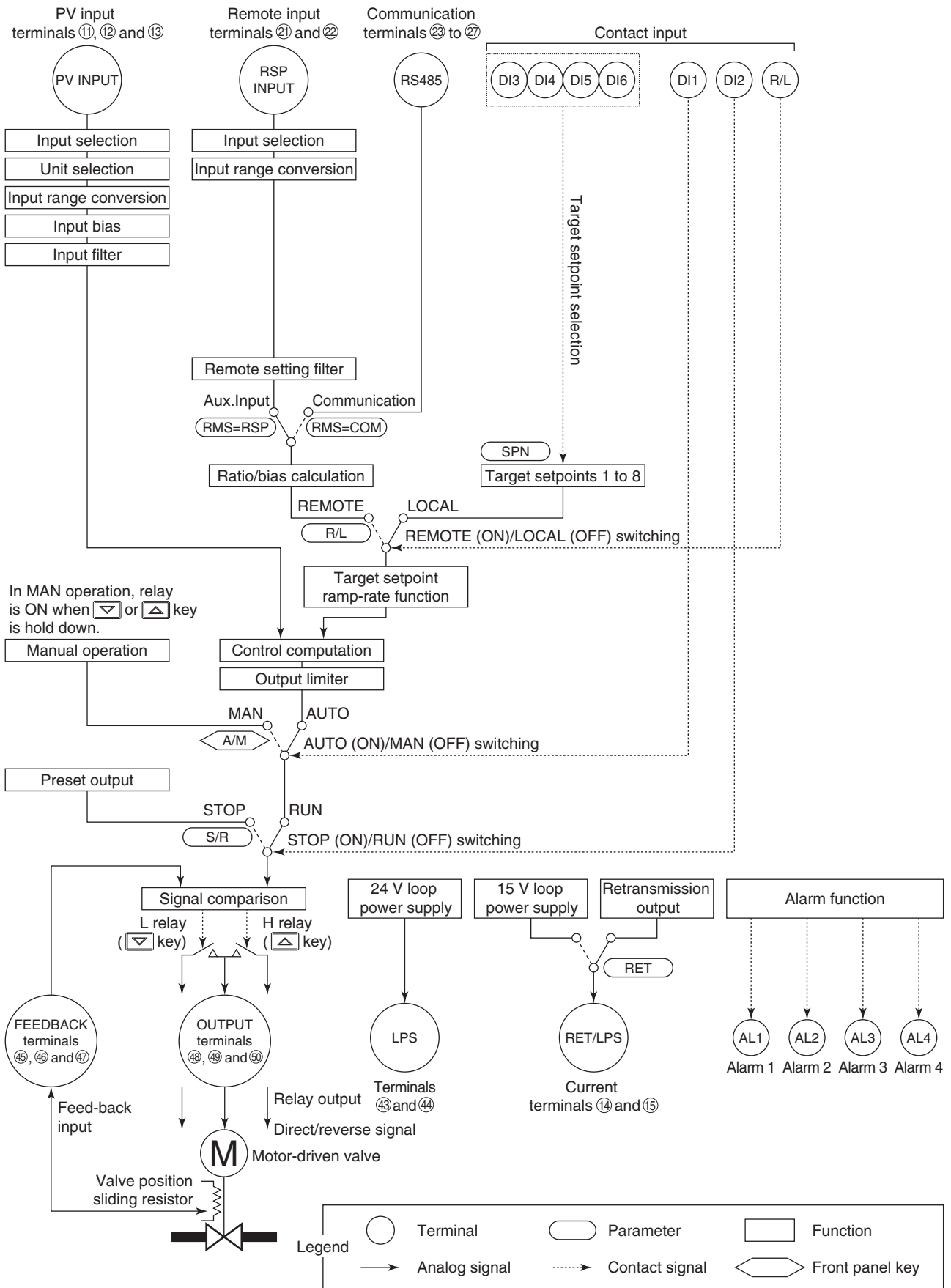

## Functions and Parameters for “Standard Type” in Initial State (Factory-set default)

Functions and parameters in initial state are given in the tables below. For details on each parameter, refer to “5.2 Lists of Parameters.”

### ■ PV Input

PV input (PV INPUT) is a universal input, which can receive signals from a thermocouple or RTD, or DC voltage signals. The controller is capable of biasing, and first-order lag computation (filtering) on input signals.

Each function can be set by the following parameters.

#### Setup Parameters

Function	Parameter	Menu
Input selection	IN	I/O
Unit selection	UNI	I/O
Input range conversion	RH, RL (DP, SH, SL)	I/O

#### Operating Parameters

Function	Parameter	Menu
PV input bias	BS	OP.PA
PV input filter	FL	OP.PA

### ■ Remote Input

Remote input (RSP INPUT) can receive DC voltage signals. The controller is capable of ratio biasing on remote input signals.

Each function can be set by the following parameters.

#### Setup Parameters

Function	Parameter	Menu
Input selection	RSP	I/O
Remote input range selection	RSH, RSL	I/O

Note: Remote input signal can be received via communication. For details, refer to “GREEN Series Communication Functions” (IM 05G01B02-01E).

#### Operating Parameters

Function	Parameter	Menu
Remote setting filter	RFL	OP.PA
Ratio bias calculation	RT, RBS	OP.PA
Remote/Local switching	R/L	OP.PA

## ■ Contact Input

Automatic (ON)/Manual (OFF) switching function is assigned to DI1 (contact input 1).

Manipulated output can be changed using the  and  keys in manual mode.

Run (OFF)/Stop (ON) switching function is assigned to DI2 (contact input 2). Preset output value is output when the operation is stopped. PV input and alarms remain functioning as normal.

It is possible to select one out of eight setpoints by turning the four contact input signals ON or OFF. This function is assigned to DI3 (contact input 3) to DI6 (contact input 6).

Contact input	Selected target setpoint number (SPN)								If all contact inputs are set to "OFF", the controller uses the immediately preceding target setpoint.
	1	2	3	4	5	6	7	8	
DI3	ON	OFF	ON	OFF	ON	OFF	ON	OFF	
DI4	OFF	ON	ON	OFF	OFF	ON	ON	OFF	
DI5	OFF	OFF	OFF	ON	ON	ON	ON	OFF	
DI6	OFF	OFF	OFF	OFF	OFF	OFF	OFF	ON	

For example, set contact input 4 (DI4) only to "ON" to change target setpoint 1 to 2. Set contact inputs 3 (DI3) and 4 (DI4) to "ON" to select target setpoint 3.

Remote (ON)/Local (OFF) mode switching function is assigned to R/L (Remote/Local mode switching contact input). External target setpoint can be set via remote input (INPUT3).

## ■ Target Setpoint and PID

It is possible to use a maximum of eight groups of target setpoints and PID parameters. The target setpoint can be selected by key operation or contact input. For selection by contact input, refer to "Contact Input."

### Operating Parameters

Function	Parameter	Menu
Target setpoint number selection	SPN	OP.PA
Target setpoints 1 to 8	n.SP	OP.PA
Proportional band (P)	n.P	OP.PA
Integral time (I)	n.I	OP.PA
Derivative time (D)	n.D	OP.PA
Cooling-side proportional band (Pc)	n.Pc	OP.PA
Cooling-side integral time (Ic)	n.Ic	OP.PA
Cooling-side derivative time (Dc)	n.Dc	OP.PA

Note: Parameters n.SP, n.P, n.I, n.D, n.Pc, n.Ic, n.Dc (n=1 to 8) correspond to the target setpoint number selected in the target setpoint number selection (SPN).

The target setpoint ramp rate setting function prevents the target setpoint from changing suddenly. It is possible to set the upward and downward changing rate (i.e., ramp rate) independently in the parameters UPR and DNR. The unit of the ramp rate (hour, or minute) is specified in TMU.

### Setup Parameters

Function	Parameter	Menu
Ramp-rate time unit setting	TMU	SP

### Operating Parameters

Function	Parameter	Menu
Target setpoint ramp-rate setting	UPR, DNR	OP.PA

## ■ Control Output

Control output (OUTPUT1) selects the output type among the current output, voltage pulse output, and relay contact output signal. For heating/cooling control, the cooling-side signals are output to OUTPUT2.

Preset output value is output when the operation is stopped by key operation or contact input, which takes priority over the manual operation.

Each function can be set by the following parameters.

### Setup Parameters

Function	Parameter	Menu
Control output type selection	OT	I/O
Control output cycle time	CT	I/O
Cooling-side control output cycle time	CTc	I/O

### Operating Parameters

Function	Parameter	Menu
Preset output	n.PO	OP.PA
Output limiter	n.OL, n.OH	OP.PA
Cooling-side preset output	n.Oc	OP.PA

Note: Parameters n.PO, n.OL, n.OH, n.Oc, (n=1 to 8) correspond to the target setpoint number selected in the target setpoint number selection (SPN).

## ■ Contact Output

Alarm 1 is output via AL1 (contact output 1).

Alarm 2 is output via AL2 (contact output 2).

Alarm 3 is output via AL3 (contact output 3).

Alarm 4 is output via AL4 (contact output 4).

### Setup Parameters

Function	Parameter	Menu
Alarm 1 type	AL1	ALM
Alarm 2 type	AL2	ALM
Alarm 3 type	AL3	ALM
Alarm 4 type	AL4	ALM

### Operating Parameters

Function	Parameter	Menu
Alarm 1 setpoint	A1	OP.PA
Alarm 2 setpoint	A2	OP.PA
Alarm 3 setpoint	A3	OP.PA
Alarm 4 setpoint	A4	OP.PA

## ■ Retransmission Output

PV, target setpoint, or control output can be output to retransmission output (RET/LPS).

Each function can be set by the following parameters.

### Setup Parameters

Function	Parameter	Menu
Retransmission output type	RET	RET
Retransmission output scale	RTH, RTL	RET

## ■ 15 V DC Loop Power Supply

The 15 V DC loop power supply (OUTPUT3) uses the same terminal as retransmission output. The 15 V DC loop power supply can not be used when retransmission output is used. To use the 15 V DC loop power supply, set "4" in retransmission output type selection parameter RET.

Each function can be set by the following parameters.

### Setup Parameters

Function	Parameter	Menu
Retransmission output type	RET	RET

---

# Revision Information

- Title : Models UT450/UT420 Digital Indicating Controllers User's Manual
- Manual No. : IM 05D01C12-41E

**Mar. 2000/1st Edition**

Newly published

**Sep. 2002/2nd Edition**

Revision

**Jul. 2004/3rd Edition**

Change of the company name

**May 2006/4th Edition**

Revision by the change of safety standard description

---

Written by Yokogawa Electric Corporation

Published by Yokogawa Electric Corporation  
2-9-32 Nakacho, Musashino-shi, Tokyo 180-8750, JAPAN

---

---

Blank Page





# YOKOGAWA

Yokogawa Electric Corporation

---

## YOKOGAWA ELECTRIC CORPORATION

### Network Solutions Business Division

2-9-32, Nakacho, Musashino-shi, Tokyo, 180-8750 JAPAN

Phone: +81-422-52-7179 Facsimile: +81-422-52-6793

### Sales Branch Offices

Tokyo, Nagoya, Osaka, Hiroshima, Fukuoka

---

## YOKOGAWA CORPORATION OF AMERICA

### Headquarters

2 Dart Road, Newnan, GA. 30265-1094 U.S.A.

Phone: +1-770-253-7000 Facsimile: +1-770-251-0928

Sales Branch Offices / Texas, Chicago, Detroit, San Jose

## YOKOGAWA EUROPE B. V.

### Headquarters

Databankweg 20, 3821 AL Amersfoort THE NETHERLANDS

Phone: +31-334-64-1611 Facsimile: +31-334-64-1610

Sales Branch Offices / Houten (The Netherlands), Wien (Austria), Zaventem (Belgium), Ratingen (Germany), Madrid (Spain), Bratislava (Slovakia), Runcorn (United Kingdom), Milano (Italy), Vélizy Villacoublay (France), Johannesburg (Republic of South Africa)

## YOKOGAWA AMERICA DO SUL S.A.

### Headquarters & Plant

Praca Acapulco, 31-Santo Amaro, Sao Paulo/SP, BRAZIL CEP-04675-190

Phone: +55-11-5681-2400 Facsimile: +55-11-5681-4434

## YOKOGAWA ENGINEERING ASIA PTE. LTD.

### Head office

5 Bedok South Road, Singapore 469270 SINGAPORE

Phone: +65-6241-9933 Facsimile: +65-6241-2606

## YOKOGAWA ELECTRIC KOREA CO., LTD.

### Seoul Sales office

395-70, Shindaebang-dong, Dongjak-gu, Seoul, 156-010, KOREA

Phone: +82-2-3284-3000 Facsimile: +82-2-3284-3019

## YOKOGAWA TAIWAN CORPORATION

### Head office

17F, No.39, Sec. 1, Chung Hwa Road Taipei, 100 TAIWAN

Phone: +886-2-2314-9166 Facsimile: +886-2-2314-9918

## YOKOGAWA AUSTRALIA PTY. LTD.

### Head office

CentreCourt D1, 25-27 Paul Street North, North Ryde, N. S. W. 2113, AUSTRALIA

Phone: +61-2-9805-0699 Facsimile: +61-2-9888-1844

## YOKOGAWA INDIA LTD.

### Head office

40/4 Lavelle Road, Bangalore, 560 001, INDIA

Phone: +91-80-227-1513 Facsimile: +91-80-227-4270

## LTD. YOKOGAWA ELECTRIC

Grokholskiy per. 13, Build. 2, 4th Floor, 129010, Moscow, RUSSIA FEDERATION

Phone: +7-095-737-7868 Facsimile: +7-095-737-7869

---